



ENGLISH (Original Instructions)

INSTRUCTION MANUAL

Cordless String Trimmer

DUR141
DUR181

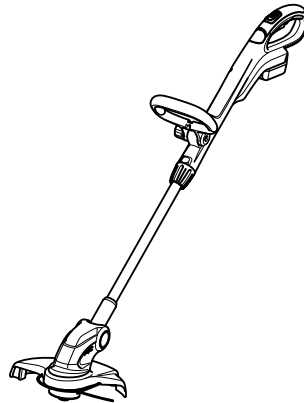

012390

IMPORTANT: Read Before Using.

ENGLISH (Original instructions)

SPECIFICATIONS













Model	DUR141		DUR181	
No load speed	6,000 min ⁻¹		7,800 min ⁻¹	
Overall length	1,229 mm - 1,433 mm		1,229 mm - 1,433 mm	
Cutting diameter with nylon cutting head	260 mm		260 mm	
Net weight	2.8 kg	3.0 kg	2.9 kg	3.1 kg
Rated voltage	D.C. 14.4 V		D.C. 18 V	
 Standard battery cartridge(s) ⚠ Warning: Use only the battery cartridge(s) described.	BL1415 / BL1415N	BL1430 / BL1430B / BL1440 / BL1450	BL1815 / BL1815N / BL1820 / BL1820B	BL1830 / BL1830B / BL1840 / BL1840B / BL1850 / BL1850B / BL1860B

- Due to our continuing program of research and development, the specifications herein are subject to change without notice.
- Specifications and battery cartridge may differ from country to country.
- Weight, with battery cartridge, according to EPTA-Procedure 01/2003

END017-4

Symbols

The following show the symbols used for the equipment. Be sure that you understand their meaning before use.

-  Take particular care and attention.
-  Read instruction manual.
-  Danger; be aware of thrown objects.
-  The distance between the tool and bystanders must be at least 15 m.
-  Keep bystanders away.
-  Keep distance at least 15 m.
-  Avoid kickback.
-  Wear a helmet, goggles and ear protection.
-  Wear protective gloves.
-  Wear sturdy boots with nonslip soles. Steeltod safety boots are recommended.
-  Do not expose to moisture.
-  Top permissible tool speed.
-  Only for EU countries
Do not dispose of electric equipment or battery pack together with household waste material!
In observance of the European Directives, on Waste Electric and Electronic Equipment and Batteries and Accumulators and Waste

Batteries and Accumulators and their implementation in accordance with national laws, electric equipment and batteries and battery pack(s) that have reached the end of their life must be collected separately and returned to an environmentally compatible recycling facility.

ENG905-1

Noise

The typical A-weighted noise level determined according to EN786:

Model DUR141

Sound pressure level (L_{pA}) : 75 dB (A)
 Sound power level (L_{WA}) : 83.7 dB (A)
 Uncertainty (K) : 2.5 dB (A)

Model DUR181

Sound pressure level (L_{pA}) : 82 dB (A)
 Sound power level (L_{WA}) : 88.5 dB (A)
 Uncertainty (K) : 2.5 dB (A)

Wear ear protection

ENG904-2

Vibration

The vibration total value determined according to EN786:

Vibration emission (a_h) : 2.5 m/s² or less
 Uncertainty (K) : 1.5 m/s²

ENG901-1

- The declared vibration emission value has been measured in accordance with the standard test method and may be used for comparing one tool with another.
- The declared vibration emission value may also be used in a preliminary assessment of exposure.

⚠ WARNING:

- The vibration emission during actual use of the power tool can differ from the declared emission value depending on the ways in which the tool is used.
- Be sure to identify safety measures to protect the operator that are based on an estimation of exposure in the actual conditions of use (taking account of all parts of the operating cycle such as the times when the tool is switched off and when it is running idle in addition to the trigger time).

ENH219-3

For European countries only**EC Declaration of Conformity****Makita declares that the following Machine(s):**

Designation of Machine:

Cordless String Trimmer

Model No./ Type: DUR141, DUR181

Specifications: see "SPECIFICATIONS" table.

Conforms to the following European Directives:

2000/14/EC, 2006/42/EC

They are manufactured in accordance with the following standard or standardized documents:

EN60745, EN60335, EN50636

The technical file in accordance with 2006/42/EC is available from:

Makita, Jan-Baptist Vinkstraat 2, 3070, Belgium

The conformity assessment procedure required by Directive 2000/14/EC was in Accordance with annex VI.

Notified Body:

TÜV Rheinland LGA Products GmbH

Tillystraße 2

90431 Nürnberg, Germany

Identification number 0197

Model DUR141

Measured Sound Power Level: 83.7 dB (A)

Guaranteed Sound Power Level: 85 dB (A)

Model DUR181

Measured Sound Power Level: 88.5 dB (A)

Guaranteed Sound Power Level: 91 dB (A)

1.10.2015



000331

Yasushi Fukaya

Director

Makita, Jan-Baptist Vinkstraat 2, 3070, Belgium

IMPORTANT SAFETY INSTRUCTIONS

⚠ WARNING! Read all safety warnings and all instructions. Failure to follow the warnings and instructions may result in electric shock, fire and/or serious injury.

Save all warnings and instructions for future reference.

1. Be familiar with the controls and proper use of the equipment.
2. Cutting elements continue to rotate after the motor is switched off.
3. Never allow children or people unfamiliar with the instructions to use the machine.
4. Stop using the machine while people, especially children, or pets are nearby.
5. Only use the machine in daylight or good artificial light.
6. Before using the machine and after any impact, check for signs of wear or damage and repair as necessary.
7. Take care against injury from any device fitted for trimming the filament line length. After extending new cutter line always return the machine to its normal operating position before switching on.
8. Never fit metal cutting elements.
9. This appliance is not intended for use by persons (including children) with reduced physical, sensory or mental capabilities, or lack of experience and knowledge, unless they have been given supervision or instruction concerning use of the appliance by a person responsible for their safety. Children should be supervised to ensure that they do not play with the appliance.
10. Use the tool with the utmost care and attention.
11. Operate the tool only if you are in good physical condition. Perform all work calmly and carefully. Use common sense and keep in mind that the operator or user is responsible for accidents or hazards occurring to other people or their property.
12. Never operate the tool when tired, feeling ill or under the influence of alcohol or drugs.
13. The tool should be switched off immediately if it shows any signs of unusual operation.

Intended use of the tool

1. Use right tool. The cordless string trimmer is only intended for cutting grass, light weeds. It should not be used for any other purpose such as hedge cutting as this may cause injury.

Personal protective equipment

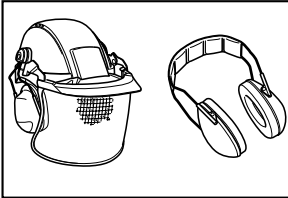

010820

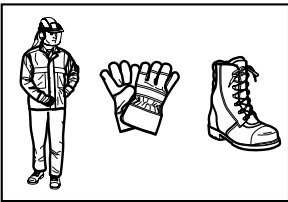

010821

1. Dress Properly. The clothing worn should be functional and appropriate, i.e. it should be tight-fitting but not cause hindrance. Do not wear either jewelry or clothing which could become entangled with high grass. Wear protective hair covering to contain long hair.
2. When using the tool, always wear sturdy shoes with a non-slip sole. This protects against injuries and ensures a good footing.
3. Wear protective glasses or goggles.

Electrical and battery safety

1. Avoid dangerous environment. Don't use the tool in damp or wet locations or expose it to rain. Water entering the tool will increase the risk of electric shock.
2. Recharge only with the charger specified by the manufacturer. A charger that is suitable for one type of battery pack may create a risk of fire when used with another battery pack.
3. Use power tools only with specifically designated battery packs. Use of any other battery packs may create a risk of injury and fire.
4. Do not dispose of the battery(ies) in a fire. The cell may explode. Check with local codes for possible special disposal instructions.

5. Do not open or mutilate the battery(ies). Released electrolyte is corrosive and may cause damage to the eyes or skin. It may be toxic if swallowed.

Starting up the tool

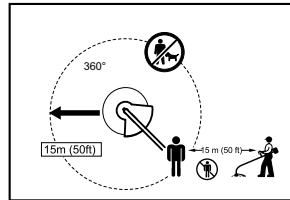

012858

1. Make sure that there are no children or other people within a working range of 15 meters (50 ft), also pay attention to any animals in the working vicinity. Otherwise stop using the tool.
2. Before use always check that the tool is safe for operation. Check the security of the cutting tool and the guard and the switch trigger/lever for easy and proper action. Check for clean and dry handles and test the on/off function of the switch.
3. Check damaged parts before further use of the tool. A guard or other part that is damaged should be carefully checked to determine that it will operate properly and perform its intended function. Check for alignment of moving parts, binding of moving parts, breakage of parts, mounting, and any other condition that may affect its operation. A guard or other part that is damaged should be properly repaired or replaced by our authorized service center unless indicated elsewhere in this manual.
4. Switch on the motor only when hands and feet are away from the cutting tool.
5. Before starting make sure that the cutting tool has no contact with hard objects such as branches, stones etc. as the cutting tool will revolve when starting.

Method of operation

1. Never operate the machine with damaged guards or without the guards in place.
2. Only use the tool in good light and visibility. During the winter season beware of slippery or wet areas, ice and snow (risk of slipping). Always ensure a safe footing.
3. Take care against injury to feet and hands from the cutting tool.

4. Keep hands and feet away from the cutting means at all times and especially when switching on the motor.
5. Never cut above waist height.
6. Never stand on a ladder and run the tool.
7. Never work on unstable surfaces.
8. Don't overreach. Keep proper footing and balance at all times.
9. Always be sure of your footing on slopes.
10. Walk, never run.
11. Remove sand, stones, nails etc. found within the working range. Foreign particles may damage the cutting tool and can cause to be thrown away, resulting in a serious injury.
12. Never touch moving hazardous parts before the machine is disconnected from the mains and the moving hazardous parts have come to a complete stop.
13. Should the cutting tool hit stones or other hard objects, immediately switch off the motor and inspect the cutting tool.
14. Before commencing cutting, the cutting tool must have reached full working speed.
15. During operation always hold the tool with both hands. Never hold the tool with one hand during use. Always ensure a safe footing.
16. All protective equipment such as guards supplied with the tool must be used during operation.
17. Except in case of emergency, never drop or cast the tool to the ground or this may severely damage the tool.
18. Never drag the tool on the ground when moving from place to place, the tool may become damaged if moved in this manner.
19. Always remove the battery cartridge from the tool:
 - whenever leaving the tool unattended;
 - before clearing a blockage;
 - before checking, cleaning or working on the tool;
 - before making any adjustments, changing accessories or storing;
 - whenever the tool starts vibrating unusually;
 - whenever transporting the tool.
20. Don't force the tool. It will do the job better and with less likelihood of a risk of injury at the rate for which it was designed.

Maintenance instructions

1. The condition of the cutting tool, protective devices must be checked before commencing work.
2. Turn off the motor and remove the battery cartridge before carrying out maintenance, replacing the cutting tool and cleaning the tool.
3. After use, disconnect the battery cartridge from the tool and check for damage.
4. Check for loose fasteners and damaged parts such as nearly halfway cut-off state in the cutting tool.
5. When not in use store the equipment in a dry location that is locked up or out of children's reach.
6. Use only the manufacturer's recommended replacement parts and accessories.
7. Always ensure that ventilation openings are kept clear of debris.
8. Inspect and maintain the tool regularly, especially before/after use. Have the tool repaired only by our authorized service center.
9. Keep handles dry, clean and free from oil and grease.

SAVE THESE INSTRUCTIONS.

WARNING:

DO NOT let comfort or familiarity with product (gained from repeated use) replace strict adherence to safety rules for the subject product. MISUSE or failure to follow the safety rules stated in this instruction manual may cause serious personal injury.

ENC007-11

IMPORTANT SAFETY INSTRUCTIONS

FOR BATTERY CARTRIDGE

1. Before using battery cartridge, read all instructions and cautionary markings on (1) battery charger, (2) battery, and (3) product using battery.
2. Do not disassemble battery cartridge.
3. If operating time has become excessively shorter, stop operating immediately. It may result in a risk of overheating, possible burns and even an explosion.
4. If electrolyte gets into your eyes, rinse them out with clear water and seek medical attention right away. It may result in loss of your eyesight.
5. Do not short the battery cartridge:
 - (1) Do not touch the terminals with any conductive material.

-
- (2) **Avoid storing battery cartridge in a container with other metal objects such as nails, coins, etc.**
 - (3) **Do not expose battery cartridge to water or rain.**

A battery short can cause a large current flow, overheating, possible burns and even a breakdown.

6. **Do not store the tool and battery cartridge in locations where the temperature may reach or exceed 50 ° C (122 ° F).**
7. **Do not incinerate the battery cartridge even if it is severely damaged or is completely worn out. The battery cartridge can explode in a fire.**
8. **Be careful not to drop or strike battery.**
9. **Do not use a damaged battery.**
10. **The contained lithium-ion batteries are subject to the Dangerous Goods Legislation requirements.**

For commercial transports e.g. by third parties, forwarding agents, special requirement on packaging and labeling must be observed.

For preparation of the item being shipped, consulting an expert for hazardous material is required. Please also observe possibly more detailed national regulations.

Tape or mask off open contacts and pack up the battery in such a manner that it cannot move around in the packaging.

11. **Follow your local regulations relating to disposal of battery.**

SAVE THESE INSTRUCTIONS.

⚠CAUTION: Only use genuine Makita batteries.

Use of non-genuine Makita batteries, or batteries that have been altered, may result in the battery bursting causing fires, personal injury and damage. It will also void the Makita warranty for the Makita tool and charger.

Tips for maintaining maximum battery life

1. **Charge the battery cartridge before completely discharged.**
Always stop tool operation and charge the battery cartridge when you notice less tool power.
2. **Never recharge a fully charged battery cartridge.**
Overcharging shortens the battery service life.
3. **Charge the battery cartridge with room temperature at 10 ° C - 40 ° C (50 ° F - 104 ° F).**
Let a hot battery cartridge cool down before charging it.
4. **Charge the battery cartridge if you do not use it for a long period (more than six months).**

PARTS DESCRIPTION

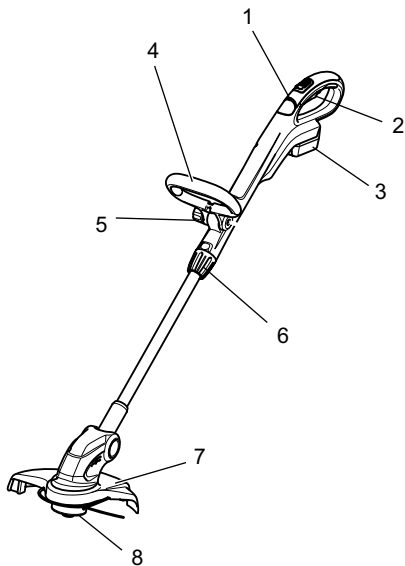

1	Indication lamp	5	Clamping nut
2	Switch trigger	6	Lock grip
3	Battery cartridge	7	Guard
4	Front grip	8	Nylon cutting head

013641

FUNCTIONAL DESCRIPTION

⚠WARNING:

- **Always be sure that the tool is switched off and battery cartridge is removed before adjusting or checking function on the tool.** Failure to switch off and remove the battery cartridge may result in serious personal injury from accidental start-up.

Installing or removing battery cartridge

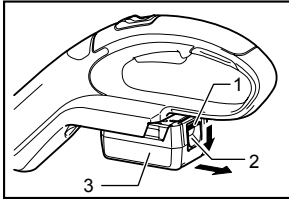

012391

1. Red indicator
2. Button
3. Battery cartridge

⚠CAUTION:

- Always switch off the tool before installing or removing of the battery cartridge.
- **Hold the tool and the battery cartridge firmly when installing or removing battery cartridge.** Failure to hold the tool and the battery cartridge firmly may cause them to slip off your hands and result in damage to the tool and battery cartridge and a personal injury.

To remove the battery cartridge, slide it from the tool while sliding the button on the front of the cartridge.

To install the battery cartridge, align the tongue on the battery cartridge with the groove in the housing and slip it into place. Insert it all the way until it locks in place with a little click. If you can see the red indicator on the upper side of the button, it is not locked completely.

⚠CAUTION:

- Always install the battery cartridge fully until the red indicator cannot be seen. If not, it may accidentally fall out of the tool, causing injury to you or someone around you.
- Do not install the battery cartridge forcibly. If the cartridge does not slide in easily, it is not being inserted correctly.

Battery protection system (Lithium-ion battery with star marking)

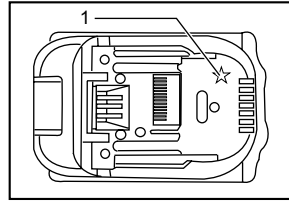

1. Star marking

012128

Lithium-ion batteries with a star marking are equipped with a protection system. This system automatically cuts off power to the tool to extend battery life.

The tool will automatically stop during operation if the tool and/or battery are placed under one of the following conditions:

- **Overloaded:**

The tool is operated in a manner that causes it to draw an abnormally high current. In this situation, release the switch trigger on the tool and stop the application that caused the tool to become overloaded. Then pull the switch trigger again to restart. If the tool does not start, the battery is overheated. In this situation, let the battery cool before pulling the switch trigger again.
- **Low battery voltage:**

The remaining battery capacity is too low and the tool will not operate. In this situation, remove and recharge the battery.

Indicating the remaining battery capacity

(Only for battery cartridges with "B" at the end of the model number.)

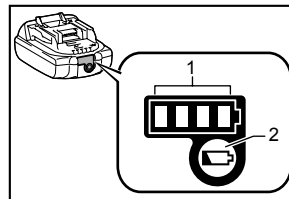

1. Indicator lamps
2. Check button

015659

Press the check button on the battery cartridge to indicate the remaining battery capacity. The indicator lamps light up for few seconds.

Indicator lamps			Remaining capacity
Lighted	Off	Blinking	
■	□	▬	75% to 100%
■	■	■	
■	■	□	50% to 75%
■	□	□	25% to 50%
■	□	□	0% to 25%
▬	□	□	Charge the battery.
■	■	□	The battery may have malfunctioned.
□	□	■	

015658

NOTE:

- Depending on the conditions of use and the ambient temperature, the indication may differ slightly from the actual capacity.

Power switch action

⚠WARNING:

- Before inserting the battery cartridge in the tool, always check to see that the switch trigger actuates properly and returns to the "OFF" position when released. Do not pull the switch trigger hard without pressing in the lock-off button. This can cause switch breakage. Operating a tool with a switch that does

not actuate properly can lead to loss of control and serious personal injury.

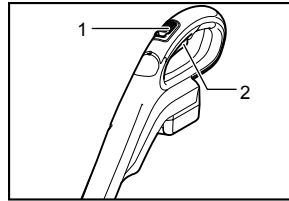

1. Lock-off button
2. Switch trigger

012397

To prevent the switch trigger from being accidentally pulled, a lock-off button is provided.

To start the tool, move the lock-off button forward and pull the switch trigger. Release the switch trigger to stop.

Indication lamp

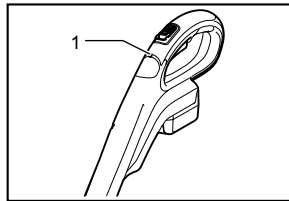

1. Indication lamp

012441

Running the tool allows the indication lamp to show the battery cartridge capacity status.

When the tool is also overloaded and has stopped during operation, the lamp lights up in red.

Refer to the following table for the status and action to be taken for the indication lamp.

Indication lamp	Status	Action to be taken
The lamp blinks in red.	This indicates the appropriate time to replace the battery cartridge when the battery power becomes low.	Recharge the battery cartridge as soon as possible.
The lamp lights up in red. (Note 1)	This function works when the battery power is almost used up. At this time, tool stops immediately.	Recharge the battery cartridge.
The lamp lights up in red. (Note 1)	Autostop due to overload.	Turn off the tool.

Note 1: The time at which the indication lamp lights up varies by the temperature around the work area and the battery cartridge conditions.

012443

Adjusting the shaft length

⚠WARNING:

- Before adjusting the shaft length, release the switch trigger and remove the battery cartridge from the string trimmer. Failure to release the trigger and removing the battery cartridge may cause a personal injury.

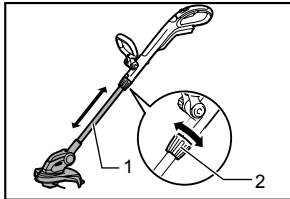

1. Shaft
2. Grip

012396

To adjust the length of the shaft, turn the grip counterclockwise until the shaft is unlocked and pull out or push in to the desired length.

Nylon cutting head

NOTICE:

- The bump feed will not operate properly if the Nylon cutting head is not rotating.

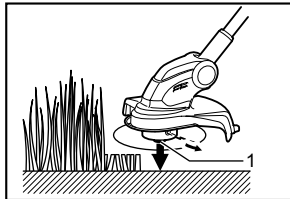

1. Nylon cutting head

012404

The nylon cutting head is a single string trimmer head provided with a bump & feed mechanism.

To cause the nylon cord to feed out, the cutting head should be bumped against the ground while the tool is running. As the nylon cord is feeding out it will automatically be cut to the proper length by the cutter on the guard.

NOTE:

- If the nylon cord does not feed out while bumping the head, rewind/replace the nylon cord by following the procedures described under "Installing or removing the Nylon cutting head" and "Winding a new Nylon cord on the spool."
- Do not bump the tool to the concrete or asphalt surface. Bumping to this kind of objects may cause the tool damage.

ASSEMBLY

⚠WARNING:

- **Always be sure that the tool is switched off and battery cartridge is removed before carrying out any work on the tool.** Failure to switch off and remove the battery cartridge may result in serious personal injury from accidental start-up.
- **Never start the tool unless it is completely assembled.** Operation of the tool in a partially assembled state may result in serious personal injury from accidental start-up.

Installing the front grip

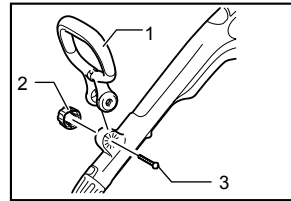

1. Front grip
2. Clamping nut
3. Hex bolt

012394

Put the front grip on the front grip holder and secure it with a hex bolt and the clamping nut provided with the string trimmer as shown in the figure. At this time, the hex bolt needs to be installed from the side in which the hex bolt lock port is located and the clamping nut needs to be installed from the opposite side.

NOTE:

- The front grip has an edge-to-edge cut slit in its mounting area. Using this slit allows you to easily install the front grip on the front grip holder.

The front grip angle is adjustable. To adjust the front grip angle, loosen the clamping nut, set the front grip at an proper angle according to your work and then tighten the nut clockwise firmly.

Installing the guard

⚠CAUTION:

- **While installing the guard, be careful not to contact the nylon cord cutter provided on the guard.** Contact with the cutter could result in personal injury.

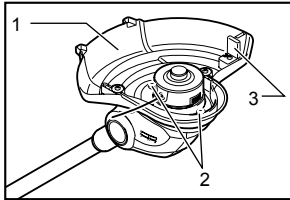

1. Guard
2. Screws
3. Cutter cover

012393

Mount the guard by fitting it on to the motor housing so that the Nylon cord is not pinched between the guard and the motor housing, and then secure it with two screws. Before starting the trimmer, take away the cutter cover from the cord cutter.

Installing or removing the Nylon cutting head

⚠WARNING:

- Before installing or removing the Nylon cutting head (both spool cover and spool, and hereafter called this way), make sure that the tool is switched off and the battery cartridge is removed from the tool. Failure to switch off the tool and remove the battery cartridge may cause a personal injury.

⚠CAUTION:

- While installing or removing the Nylon cutting head, be careful not to contact the nylon cord cutter provided on the guard. Contact with the cutter could result in personal injury.

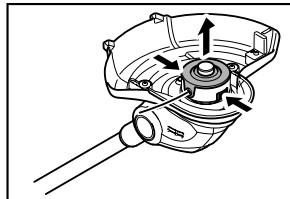

012408

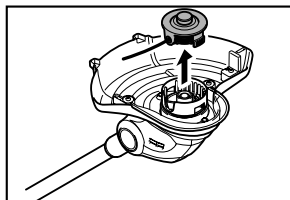

012409

To remove the Nylon cutting head (spool and spool cover) from the string trimmer, press in the latches forcefully on both sides of the spool cover and raise it.

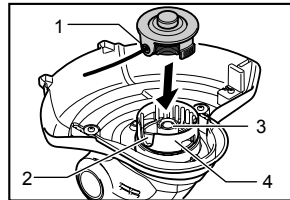

1. Nylon cord eyehole
2. Notch of the nylon cutting head installation port
3. Spring
4. Spool holder

012440

NOTICE:

- Make sure that the spring is installed inside the spool holder.

To install a cord-newly-wound Nylon cutting head (spool and spool cover) on the string trimmer, align the Nylon cord eyehole with the notch of the Nylon cutting head installation port on the trimmer and then press in it until a click is heard.

Winding a new Nylon cord on the spool

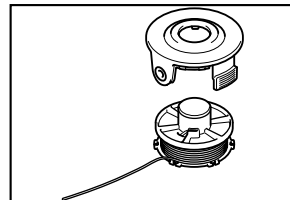

012412

Remove the spool from the spool cover and take off the remaining used Nylon cord from the spool.

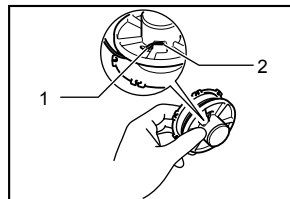

1. Nylon cord
2. Retainer for nylon cord end

012413

Insert a Nylon cord to the retainer shown in the figure.

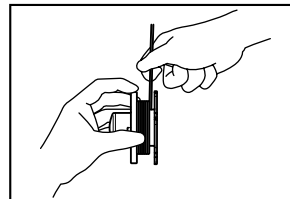

012414

Wind it tightly flat around the spool in the direction of arrow on the spool so that the wound Nylon cord surface appears uniform over the winding area.

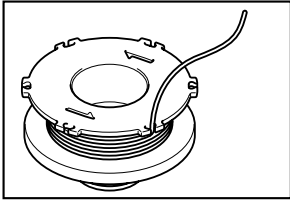

012415

Temporarily fix a Nylon cord at the notch shown in the figure.

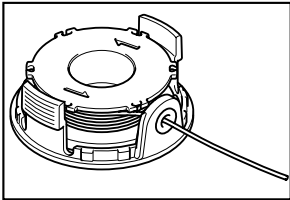

012416

Bring the Nylon cord through the Nylon cord eyehole in the spool cover.

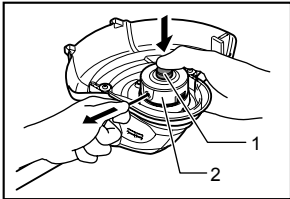

012417

After installing the Nylon cutting head, make sure that the Nylon cord comes out by pressing the spool and pulling the Nylon cord.

- 1. Spool
- 2. Nylon cord

OPERATION

Attachment of shoulder strap

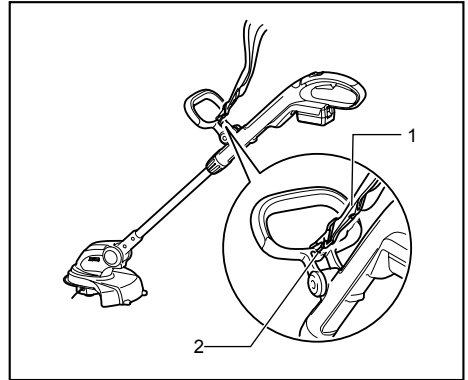

- 1. Shoulder strap
- 2. Hook

012395

Hook the shoulder strap in a hole in the front grip.

OPERATION

⚠CAUTION:

- **Do not cut high grass at a time.** Cutting high grass at a time near the root may cause the trimmer motor spindle to be entangled by grass which leads to the motor under overload, resulting in damage to the trimmer.

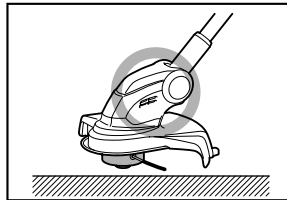

012399

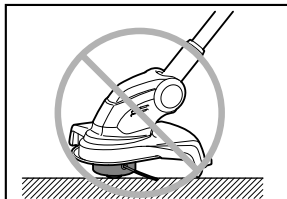

012400

⚠ CAUTION:

- Use the trimmer without getting the spool into a contact with the ground surface. Using the spool contacting the ground surface may cause the motor under overload resulting in damage to the trimmer.

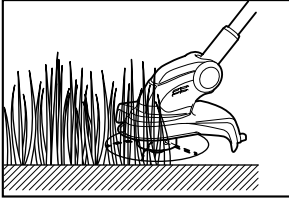

012401

⚠ CAUTION:

- Do not force the trimmer in densely growing grass.

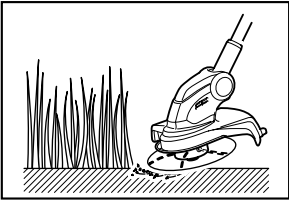

012402

⚠ CAUTION:

- Do not use the trimmer as if you dig out the ground with it.

Cutting the grass near a tree, concrete block, brick or garden stone

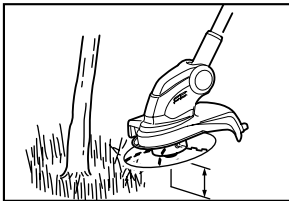

012403

Hold the trimmer tilting at a level so that it does not contact the ground surface and cut the grass using the Nylon cord tip like knocking the ground. In this work, smooth feeding out is needed because the Nylon cord wears more quickly than usual.

NOTE:

- Getting the trimmer too close to a tree, concrete block, brick or garden stone or the like during performing the edging work or such similar cutting work may cause the Nylon cord to be cut off

halfway inside the spool cover. At this time, take the spool out of the spool cover and then set the Nylon cord again properly by referring to the section titled "Installing or removing the Nylon cutting head" and "Winding a new Nylon cord on the spool". Using the tip of the Nylon cord during operation brings the best result of operation and therefore it is recommended to keep the tool more than 5 cm away from the tree, concrete block, brick or garden stone or the like.

Start the trimmer before getting close to the grass to be cut.

Cut the grass using the Nylon cord tip by moving the trimmer from right to left and proceed slowly, keeping the trimmer tilted at the angle of about 30° in relation to the ground surface.

When cutting high grass, cut in layers always beginning from the top with each cut length short.

Using the tool as an edger

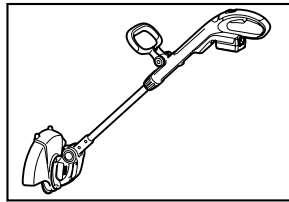

012406

Using the tool as an edger allows the operator to cut along the edge of the concrete block, brick and the like.

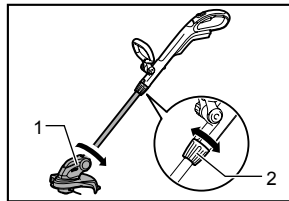

012405

1. Motor housing
2. Grip

For using the tool as an edger, hold the shaft of the trimmer with one hand and turn the grip counter clockwise to loosen the shaft. Rotate the shaft with the motor housing 180° and tighten the grip clockwise until it locks.

NOTE:

- Before rotating the shaft, it needs to be fully shortened or extended.
- After changing to the edger position, make sure that the motor housing and shaft are locked.

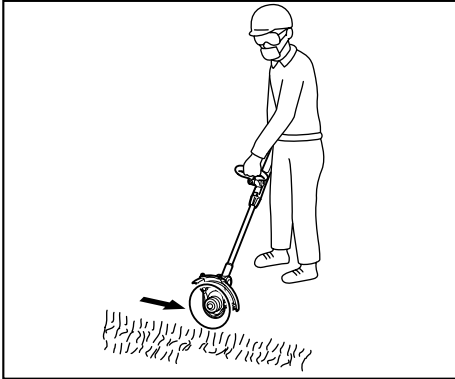

012407

To obtain a good result of finish cutting, move parallel to the edge you are going to perform an edging work.

Cutting the grass in a tight place or on a slope

⚠WARNING:

- When cutting the grass on a slope, be careful of stones, grass and other foreign objects thrown from the cutting head area.
- When cutting the grass on a slope, make sure that you always keep a good and stable footing.

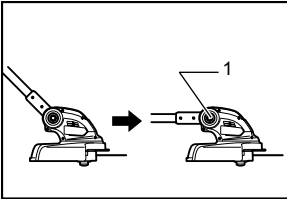

012398

1. Lock button

To ease the work in a tight place which restricts the height, such as cutting the grass under an outdoor wood deck and similars, push the lock button and then bend down the cutting head so that the shaft is parallel to the ground surface. Adjusting the cutting head angle properly in this way helps you cut the grass on a slope.

MAINTENANCE

⚠WARNING:

- **Always be sure that the tool is switched off and battery cartridge is removed before attempting to perform inspection or maintenance on the tool.** Failure to switch off and remove the battery cartridge may result in serious personal injury from accidental start-up.

NOTICE:

Never use gasoline, benzine, thinner, alcohol or the like. Discoloration, deformation or cracks may result.

To maintain product SAFETY and RELIABILITY, repairs, any other maintenance or adjustment should be performed by Makita Authorized Service Centers, always using Makita replacement parts.

OPTIONAL ACCESSORIES

⚠CAUTION:

- These accessories or attachments are recommended for use with your Makita tool specified in this manual. The use of any other accessories or attachments might present a risk of injury to persons. Only use accessory or attachment for its stated purpose.

If you need any assistance for more details regarding these accessories, ask your local Makita Service Center.

- Nylon cutting head
- Nylon cords
- Shoulder strap
- Goggles
- Makita genuine battery and charger

NOTE:

- Some items in the list may be included in the tool package as standard accessories. They may differ from country to country.

Makita Jan-Baptist Vinkstraat 2, 3070, Belgium
Makita Corporation Anjo, Aichi, Japan