



ARC200PFC/ARC160PFC

ARC200/ARC160

IGBT INVERTER WELDER

Thank you for selecting this new JASIC equipment!

This operating manual contains important information on the use and maintenance of this product, as well as safe handling of the product. Please refer to technical parameters of the equipment in Technical Parameter section in this manual, and read the manual carefully before using the equipment for the first time. For your own safety and that of your working environment, please pay particular attention to the safety instructions in the manual and operate the equipment according to the instructions. For more information on JASIC products, please contact JASIC Technology, consult an authorized JASIC dealer or visit JASIC website at www.jasictech.com.

Disclaimer

Shenzhen JASIC Technology Co., Ltd. solemnly promises that this product is manufactured according to relevant domestic and international standards, and that this product conforms to EN60974-1 International Safety Standard. Patents protect the relevant design scheme and manufacturing technology adopted in this product.

1. Whilst every effort has been made to ensure that the information contained within this manual is complete and accurate, no liability can be accepted for any errors or omissions. Please note products are subject to continual development and may be subject to change without notice.
2. Though contents in this manual have been carefully checked, there may be inaccuracies. Please do not hesitate contact us in case of any inaccuracy.
3. Do not copy, record, reproduce or transmit the contents of this manual without prior permission from JASIC.

Manufacturer: Shenzhen JASIC Technology Co. Ltd

Registered Trademark: JASIC

Registered Address: No.3 Qinglan 1st Road, Pingshan District, Shenzhen, Guangdong, China

Postcode: 518118

Tel: +86 (0755) 8670 6250

Fax: +86 (0755) 27364108

Website: www.jasictech.com

E-mail: sales@jasictech.com

Contents

1. Safety precautions.....	6
1.1. General safety.....	6
1.2. Other precautions.....	9
2. Description of symbols.....	10
3. Product overview.....	11
4. Technical parameters.....	12
5. Installation.....	14
5.1. External interface description.....	14
5.2. Power installation.....	15
5.3. MMA electrode holder and earth cable connection.....	16
5.4. LIFT TIG welding torch and earth cable connection.....	17
5.5. Wired hand-held remote-control connection (optional).....	18
(Not optional for standard version without remote control interface).....	18
5.6. Installation of wireless receiver module (optional).....	18
6. Control panel.....	20
6.1. Overview.....	20
6.2. Display of parameters and error codes.....	21
6.3. Parameter adjustment knob.....	21
6.4. Selection of working mode.....	21
6.5. Selection of welding electrode diameter for MMA.....	22
6.6. Selection of MMA parameters.....	22
6.7. LIFT TIG mode parameter setting.....	23
6.8. Protection indicators.....	23
6.9. VRD (Voltage reduction device) function indications.....	23
6.10. Barcode display.....	23
6.11. Restore factory settings.....	23
6.12. Wired hand-held remote control (optional).....	24
6.13. Wireless remote control (optional).....	24
7. Welding function operation.....	25
7.1. MMA operation.....	25
7.2. LIFT TIG operation.....	29
8. Maintenance.....	31
8.1 Power supply maintenance.....	31
8.2 Welding torch maintenance.....	32
9. Troubleshooting.....	34
9.1. Common malfunction analysis and solution.....	34
9.2. Alarm and solutions.....	37
10. Packaging, transportation, storage and waste disposal.....	38
10.1 Transportation requirements.....	38
10.2 Storage conditions.....	38
10.3 WEEE waste disposal.....	38
Appendix 1: Wiring diagram.....	39
Appendix 2: Exploded view of ARC160 and ARC200.....	40

Appendix 3: Exploded view of ARC160PFC and ARC200PFC..... 43

For your safety, please read this manual carefully before installing and operating this JASIC equipment.

Pay extra attention to all content marked with  .

All operations must be carried out by professional, suitably qualified persons!

1. Safety precautions

1.1. General safety

 **SAFETY INSTRUCTION**

These general safety norms cover both arc welding machines and plasma cutting machines unless otherwise noted.

It is important that users of this equipment protect yourselves and others from harm or even death.



The equipment must only be used for the purpose it was designed for. Using it in any other way could result in damage or injury and in breach of the safety rules.



Only suitably trained and competent persons should use the equipment.



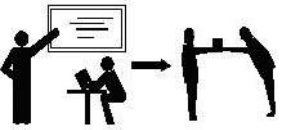

Pacemaker wearers should consult your doctor prior to using this equipment

PPE and workplace safety equipment must be compatible for the application of work involved.

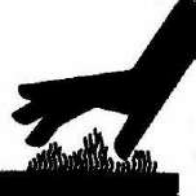
Always carry out a risk assessment before carrying out any welding or cutting activity

	<p>Only qualified personnel should operate this machine!</p> <ul style="list-style-type: none"> · Always use the appropriate personal protective equipment. · Always pay attention to the safety of other persons around the working zone · Do not carry out any maintenance with the power on the machine
	<p>Electric shock—May cause serious injury or even death!</p> <ul style="list-style-type: none"> · The equipment should be installed by a qualified person and in accordance with current standards in operation. It is the users responsibility to ensure that the equipment is connected to a suitable power supply. Consult with your utility supplier if required. Do not use the equipment with the covers removed. · Do not touch live electrical parts or parts, which are electrically charged. · Turn off all equipment when not in use.
	<p>Fumes and gases—May be hazardous to your health.</p> <p>Locate the equipment in a well-ventilated position and keep your head out of the fume.</p> <p>Do not breathe the fume.</p> <p>Ensure the working zone is well ventilated and provision should be made for suitable local fume extraction system to be in place.</p> <p>If ventilation is poor, wear an approved air fed welding helmet or respirator.</p> <p>Read and understand the Material Safety Data Sheets (MSDS's) and the manufacturer's instructions for metals, consumable, coatings, cleaners and de-greasers.</p> <p>Do not work in locations near any de-greasing, cleaning or spraying operations. Be aware that heat and rays of the arc can react with vapours to form highly toxic and irritating gases.</p>

	<p>Arc rays—May injure the eyes and burn the skin.</p> <p>The arc rays from all processes produce intense, visible and invisible (ultraviolet and infrared) rays that can burn eyes and skin.</p> <ul style="list-style-type: none"> ·Wear an approved welding helmet fitted with an appropriate shade of filter lens to protect your face and eyes when working or watching. ·Wear approved safety glasses with side shields under your helmet. ·Never use broken or faulty welding helmets. ·Always ensure there are adequate protective screens or barriers to protect others from flash, glare and sparks from the working area. ·Ensure that there are adequate warnings that welding or cutting is taking place. ·Wear suitable protective flame resistant clothing, gloves and footwear.
	<p>Precautions against fire and explosion</p> <p>Avoid causing fires due to sparks and hot waste or molten metal.</p> <p>Ensure that appropriate fire safety devices are available near the welding and cutting area.</p> <p>Remove all flammable and combustible materials from the welding, cutting and surrounding areas.</p> <p>Do not weld or cut fuel and lubricant containers, even if empty. These must be carefully cleaned before they can be welded or cut.</p> <p>Always allow the welded or cut material to cool before touching it or placing it in contact with combustible or flammable material.</p> <p>Do not work in atmospheres with high concentrations of combustible fumes, flammable gases and dust.</p> <p>Always check the work area half an hour after cutting to make sure that no fires have begun.</p> <p>Take care to avoid accidental contact of electrode to metal objects. This could cause arcs, explosion, overheating or fire.</p>
	<p>Risks due to hot material</p> <p>The process will create hot metal, sparks and drips of molten metal, so its very important to ensure the operator is equipped with full PPE and to always ensure there are adequate protective screens or barriers to protect others from flash, glare and sparks from the working area. Hot surfaces will create fires and will burn any exposed skin.</p> <p>Always protect your eyes and body. Use the correct welding screen and filter lens and wear full PPE protective clothing.</p> <p>Do not touch any hot surfaces or parts bare handed.</p> <p>Always allow hot surfaces and parts to cool down first before touching or moving.</p> <p>If you are required to move hot parts, ensure you use proper tools and insulated welding gloves (PPE) to prevent burns to your hands and arms.</p>

	<p>Noise—Excessive noise may be harmful to hearing</p> <ul style="list-style-type: none"> ·Protect your ears by ear shields or other hearing protectors. ·Give warning to nearby personnel that noise may be potentially hazardous to hearing.
	<p>Risks due to magnetic fields</p> <p>The magnetic fields created by high currents may affect the operation of pacemakers or electronically controlled medical equipment.</p> <p>Wearers of vital electronic equipment should consult their physician before beginning any arc welding, cutting, gouging or spot welding operations.</p> <p>Do not go near welding equipment with any sensitive electronic equipment as the magnetic fields may cause damage.</p> <p>Keep the torch cable and work return cable as close to each other as possible throughout their length, this can help minimise your exposure to harmful magnetic fields.</p> <p>Do not wrap the cables around the body.</p>
	<p>Protection from moving parts</p> <p>When the machine is in operation keep away from moving parts such as motors and fans.</p> <p>Moving parts, such as the fan, may cut fingers and hands and snag garments.</p> <p>Protections and coverings may be removed for maintenance and controls only by qualified personnel after first disconnecting the power supply cable.</p> <p>Replace the coverings and protections and close all doors when the intervention is finished and before starting the equipment.</p> <p>Take care to avoid getting fingers trapped when loading and feeding wire during set up and operation.</p> <p>When feeding wire be careful to avoid pointing it at other people or towards your body.</p> <p>Always ensure machine covers and protective devices are in operation.</p>
	<p>Troubleshooting</p> <p>Before the machines are dispatched from the factory, they have already been checked thoroughly. The machine should not be tampered with or altered.</p> <p>Maintenance must be carried out carefully. If any wire becomes loose or is misplaced, it maybe potentially dangerous to user!</p> <p>Only professional maintenance personnel should repair the machine!</p> <p>Ensure the power is disconnected before working on the machine. Always wait 5 minutes after power switch off before removing the panels.</p> <p>If you still do not fully understand or cannot solve the problem after reading the instructions in this manual, you should contact the supplier or JASIC's service center immediately for professional help.</p>

1.2. Other precautions



Warning! Location

The machine should be located in a suitable position and environment. Care should be taken to avoid moisture, dust, steam, oil or corrosive gases. Place on a secure level surface and ensure that there is adequate clearance around the machine to ensure natural airflow.



Warning! The handle or strap on the machine is only suitable for manual lifting of the machine. If mechanical equipment such as crane is used to lift the machine, please ensure the machine is secured with suitable lifting equipment.



Warning!

Input connection

Before connecting the machine, you should ensure that the correct supply is available. Details of the machine requirements can be found on the data plate of the machine or in the technical parameters shown in the manual. The equipment should be connected by a suitably qualified competent person. Always ensure the equipment has a proper grounding.

Never connect the machine to the mains supply with the panels removed.

- 1) When the operator's movement is limited by the surroundings (for example, the operator can only bend his knees, barefoot, or lie down during operation), the operator shall practice proper insulation and avoid direct contact with conductive parts on the equipment.
- 2) Do not use the machine in closed containers in narrow spaces where conductive components cannot be removed.
- 3) Do not use the machine in humid environments where the operator is prone to the risk of electric shock.
- 4) Do not use the machine in sunlight or rain, and no water or rainwater shall seep into the machine.
- 5) Do not perform gas shielded welding in an environment with strong air flow.
- 6) Avoid welding or cutting in dusty area or environment with corrosive chemical gas.
- 7) The ambient temperature must be between -10° C and 40° C during operation and between -25° C and 50° C during storage.
- 8) Welding or cutting shall be carried out in a relatively dry environment, and the air humidity shall not exceed 90%.
- 9) The inclination of the machine shall not exceed 10°.
- 10) Ensure that the input power supply voltage does not exceed 15% of the rated voltage of the machine.
- 11) Beware of falling when welding or cutting at heights.

2. Description of symbols



Read this operation manual carefully before use.



Warning in operation.



Single-phase static frequency converter-transformer rectifier.

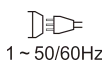

Symbol of single-phase AC power supply and rated frequency.



Can be used in the environment which has high risk of electric shock.

IP Degree of protection, such as IP23S.

U₁ Rated AC input voltage (with tolerance $\pm 15\%$)

I_{1max} Rated maximum input current

I_{1eff} Maximum effective input current

X Duty cycle The ratio of given duration time/the full-cycle time

Note1: This ratio shall be within 0~1, and can be indicated by percentage.

Note2: In this standard, the full-cycle time is 10 min.

For example, if the duty cycle is 60%, the load-applying time shall be 6 min and the following no-load time shall be 4min.

U₀ No-load voltage, Open circuit voltage of secondary winding.

U₂ Load voltage

H Insulation class



It's forbidden to dispose electric waste with other ordinary waste. Please take care of our environment.



Electric shock risk warning

A Current unit "A"



Overheat protection indicator



Overcurrent protection indicator



VRD function indicator



MMA mode



LIFT TIG mode









ϕ ...

ϕ 2.5

ϕ 3.2

ϕ 4.0

Selection of welding electrode diameter for MMA

-  MMA current
-  Hot start current of MMA
-  Arc force of MMA
-  Welding mode switching
-  Other function switching
-  Wireless indication
-  Remote control
-  Pairing of wireless remote controller

3. Product overview

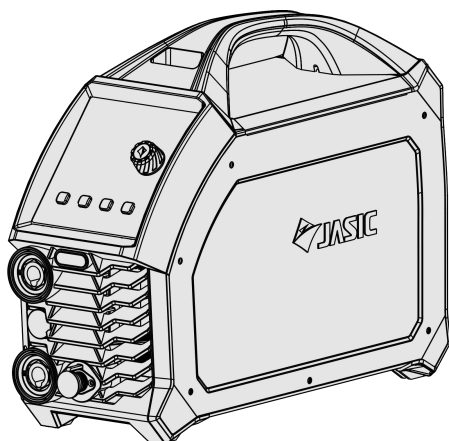

This is a digital inverter DC manual welder featuring advanced technology which provides excellent performance. It provides stable DC arc and can weld carbon steel, low alloy steel, stainless steel and other materials. Moreover, it offers adjustable Hot start and Arc force functions. It is a durable machine with a wide range of applications.

With **DC MMA** and **LIFT TIG** processes, it can be widely used in precise welding of an extensive range of materials. The unique electrical structure and air passage design inside the machine increases the dissipation of heat generated by power devices, thus improving the duty cycle of the machine. Benefitting from the unique air passage, the equipment can effectively prevent damage to power devices and control circuits from dust drawn in by the fan, thus greatly improving the reliability of the equipment.

The main functions are:

- ◆ Two welding processes: DC MMA and LIFT TIG.
- ◆ Current settings, Arc force and Hot start current are displayed for more accurate adjustment.

- ◆ Anti-stick function: prevents the welding electrode from sticking to the work piece during welding.
- ◆ Synergic function: the current is set automatically to match the selected electrode diameter, making the welder easier to use
- ◆ MMA Hot start function: makes MMA arc ignition easier and more reliable.
- ◆ On-demand fan: prolongs the life span of fan and reduce the accumulation of dust inside the machine.
- ◆ Arc ignition function: HF TIG ignition with provide reliable arc ignition.
- ◆ Parameters are automatically saved before shutdown, and the settings are restored after starting again.
- ◆ Parameters factory restore.
- ◆ Wired hand-held remote control and wireless remote control are optional. (Not optional for standard version which has no remote control interface)

4. Technical parameters

Item	Unit	Parameters			
Model	/	ARC200PFC	ARC160PFC	ARC200	ARC160
Input voltage	VAC	AC95~265V	AC95~265V	AC230V±15%	AC230V±15%
Input frequency	Hz	50/60	50/60	50/60	50/60
Rated input current (AC230V)	A	19.6@TIG 29.7@MMA	14@TIG 22.6@MMA	27@TIG 39@MMA	24@TIG 33@MMA
Rated input current (AC115V)	A	27.2@TIG 31.2@MMA	23.3@TIG 28.7@MMA	/	/
Rated input power (AC230V)	kVA	4.5@TIG 6.8@MMA	3.2@TIG 5@MMA	6.2@TIG 9@MMA	5.5@TIG 7.6@MMA
Rated input power (AC115V)	kVA	3.1@TIG 3.6@MMA	2.7@TIG 3.3@MMA	/	/
Welding current range (TIG) (AC230V)	A	10 ~ 200	10 ~ 160	10 ~ 200	10 ~ 160
Welding current range (MMA) (AC230V)	A	20 ~ 200	20 ~ 160	20 ~ 200	20 ~ 160
Welding current range (TIG) (AC115V)	A	10 ~ 160	10 ~ 120	/	/

Welding current range (MMA) (AC115V)	A	20 ~ 120	20 ~ 110	/	/
Welding voltage range (TIG) (AC230V)	V	10.4 ~ 18	10.4 ~ 16.4	10.4 ~ 18	10.4 ~ 16.4
Welding voltage range (MMA) (AC230V)	V	20.4 ~ 28	20.4 ~ 26.4	20.4 ~ 28	20.4 ~ 26.4
Welding voltage range (TIG) (AC115V)	V	10.4 ~ 16.4	10.4 ~ 14.8	/	/
Welding voltage range (MMA) (AC115V)	V	20.4 ~ 24.8	20.4 ~ 24.4	/	/
Arc force range	A	0 ~ 60	0 ~ 60	0 ~ 60	0 ~ 60
Hot start current range	A	0 ~ 60	0 ~ 60	0 ~ 60	0 ~ 60
No-load voltage	V	78	78	62	62
VRD voltage	V	11	11	11	11
Arc start mode		Contact arc start	Contact arc start	Contact arc start	Contact arc start
Duty cycle (%)	%	TIG: 200@25% MMA: 200@25%	TIG: 160@25% MMA: 160@25%	TIG: 200@25% MMA: 200@25%	TIG: 160@25% MMA: 160@25%
Power factor		0.99	0.99	0.72	0.64
Insulation class		H	H	H	H
Protection class		IP23S	IP23S	IP23S	IP23S
Dimensions L*W*H	mm	413*150*311	413*150*311	375*131*252	375*131*252
Net weight	Kg	7.2	7.2	5.5	5.5
Overall total weight	Kg	9.0	9.0	6.5	6.5
Power supply efficiency (at maximum input current)	%	85	86	86	86.5
Idle state power	W	47	38.2	26	22.6
Characteristic		CC	CC	CC	CC
Pollution level		Level 3	Level 3	Level 3	Level 3

5. Installation



Warning! All connections shall be made with the power supply is turned off.
Warning! Electric shock may cause death; after power failure, there is still a high voltage on the equipment, do not touch the live parts on the equipment.
Warning! Incorrect input voltage may damage the equipment.
Warning! This product meets the requirements of Class A equipment in EMC requirements and is not to be connected to a residential low-voltage power supply grid.

5.1. External interface description

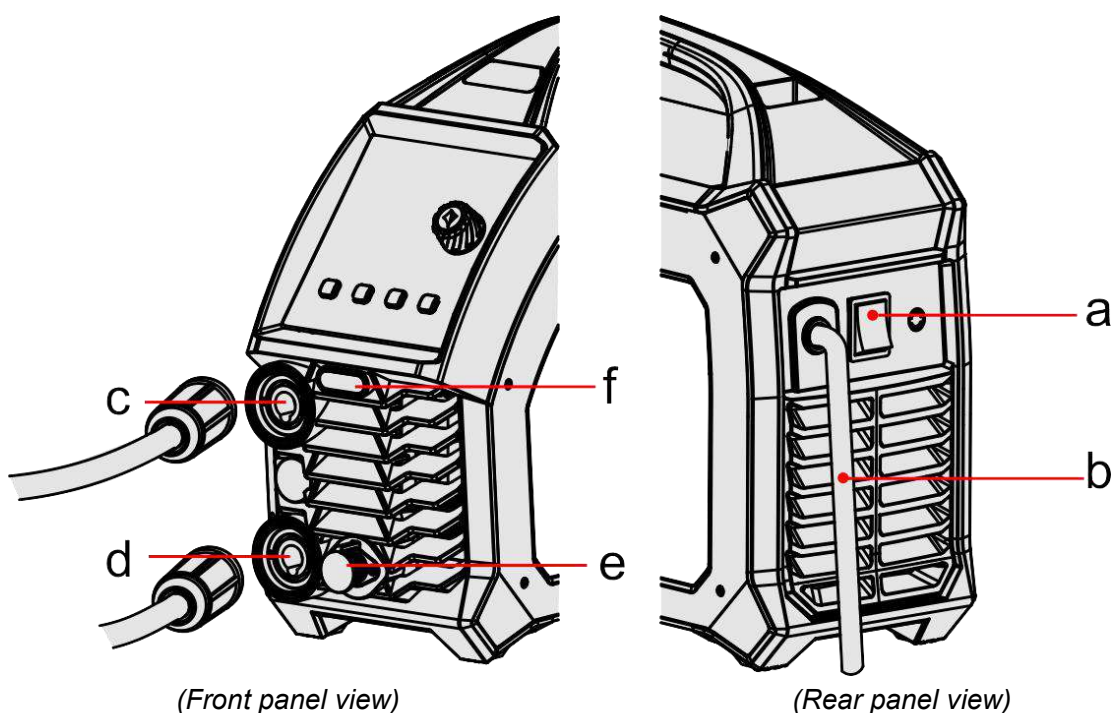

- a. Power switch
- b. Input power cord
- c. Output positive polarity
- d. Output negative polarity
- e. Wired hand-held remote control (optional) (Not optional for standard version which has no remote control interface)
- f. Wireless remote control (optional) (Not optional for standard version which has no remote control interface)

5.2. Power installation

Warning! The electrical connection of equipment shall be carried out by suitably qualified personnel.



Warning! All connections shall be made after the power supply is off.

Warning! Incorrect voltage may damage the equipment.

- 1) Test with multi-meter to ensure the input voltage value is within the specified input voltage range.
- 2) Ensure that the power switch of the welder is turned off.
- 3) Connect the input power cord to the input terminal or plug the power cord into the corresponding socket (if any) and ensure a good contact.
- 4) Ground the power supply well. (As shown in the diagram, the European plug has a grounding terminal, so no additional grounding is required.)

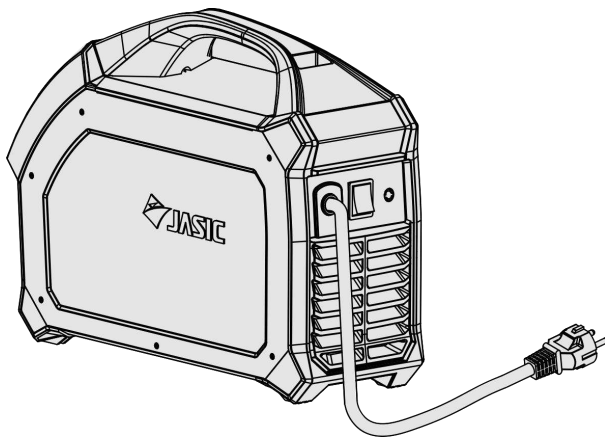

(Wiring diagram)

NOTE!

If the input cable needs to be extended, please use a cable with larger cross-sectional area to reduce the voltage drop, 3x2.5mm² or more is recommended.

5.3. MMA electrode holder and earth cable connection

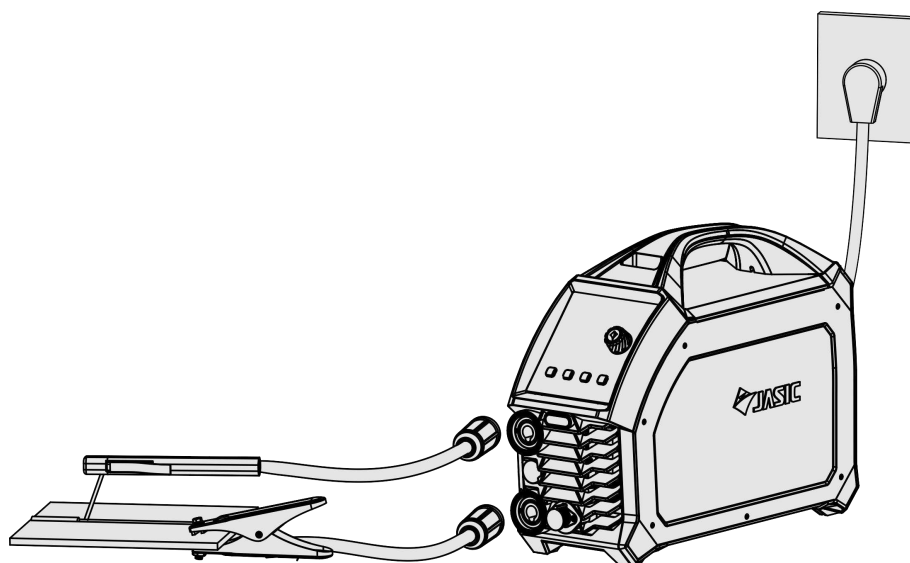

(Wiring diagram)

Pay attention to the polarity of wiring before MMA welding. Generally, there are two connection methods of DC welder: DCEN and DCEP connection.

DCEN: the welding electrode holder is connected to the negative polarity, and the workpiece is connected to the positive polarity.

DCEP: the electrode holder is connected to the positive polarity, and the workpiece is connected to the negative polarity.

The operator can choose DCEN based on the base metal and welding electrode. Generally speaking, DCEP is recommended for basic electrodes (i.e., electrode connected to the positive polarity), while no special provisions are made for acid electrodes.

- 1) Ensure that the power switch of the welder is turned off.
- 2) Insert the cable plug with welding electrode holder into the corresponding socket under the front panel of the welder and tighten it clockwise.
- 3) Insert the cable plug with earth clamp into the corresponding socket under the front panel of the welder and tighten it clockwise.

NOTE! If you want to use long secondary cables (electrode holder and earth cable), you must ensure that the cross-sectional area of the cable is increased appropriately in order to reduce the voltage drop due to the cable length.

5.4. LIFT TIG welding torch and earth cable connection

- 1) Ensure that the power switch is turned off.
- 2) Insert the cable plug with the earth clamp into the positive socket on the front panel of the welder and tighten it clockwise.
- 3) Insert the cable plug of the welding torch into the corresponding negative socket on the front panel of the welder and tighten it clockwise.

Note! The positive and negative polarities should not be reversed as this will prevent normal welding operation.

- 4) Connect the shield gas pipe input end of the welding torch to the output gas connection of the gas pressure regulator and secure it firmly with a clamp.

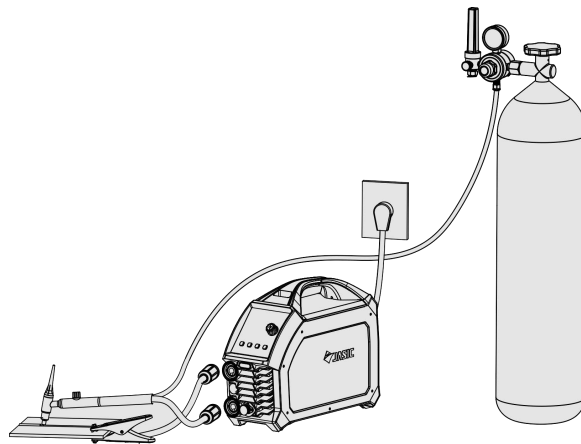

(Wiring diagram)

NOTE! If you want to use long secondary cables (TIG torch and earth cable), you must ensure that the cross-sectional area of the cable is increased appropriately in order to reduce the voltage drop due to the cable length.

5.5. Wired hand-held remote-control connection (optional)

(Not optional for standard version without remote control interface)

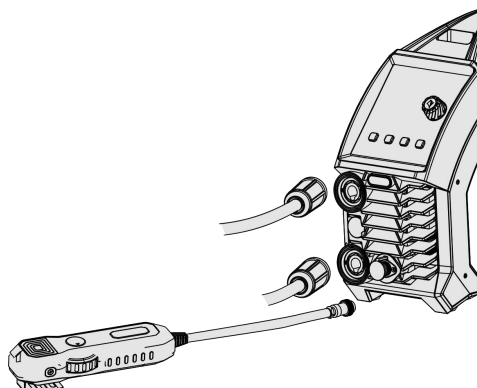

(Wiring diagram)

Insert the 3-pin aviation plug of the hand-held remote controller directly into the corresponding remote socket of the machine.

NOTE: Please check that the machine supports wired hand-held remote control before installation.

5.6. Installation of wireless receiver module (optional)

(Not optional for standard version without remote control interface)

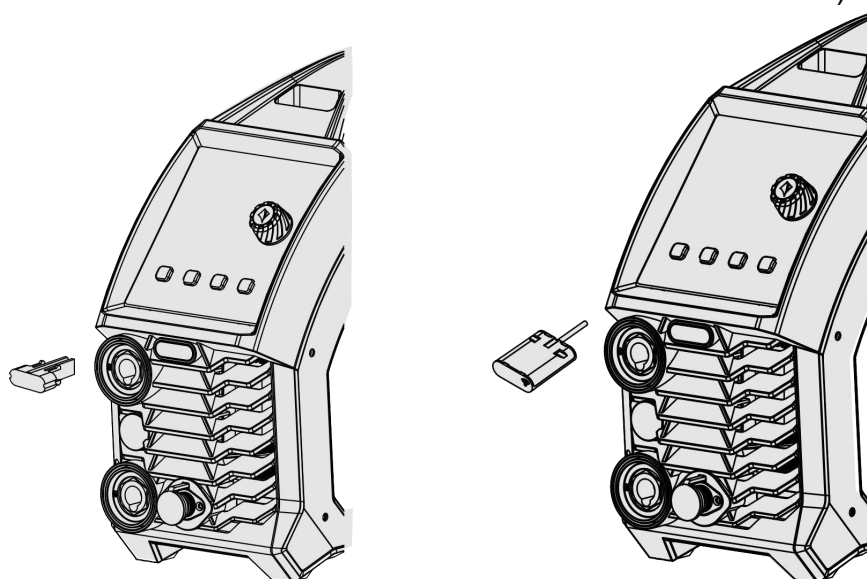

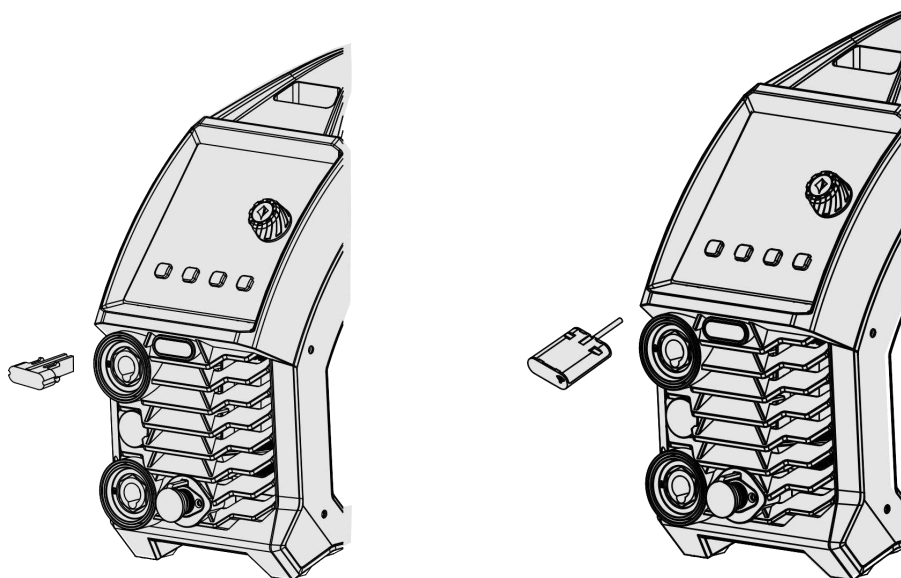

(Installation drawing)

- 1) Remove the plug shown in above left drawing, and refit into the space the wireless receiver module shown in above right drawing.
- 2) Remove the screws on the left side cover of the machine.
- 3) Remove the buckle inside the front panel of the machine and pull out the plug.

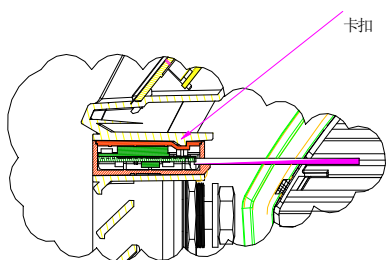

- 4) Insert the wireless receiver module to the front panel, and then connect the connection line of the receiver module to the CN5 socket on the main board.

NOTE: Please check that the machine supports wired hand-held remote control before installation.

6. Control panel

6.1. Overview



- a. Parameter and error code display
- b. Protection indicator
- c. Operation mode selector
- d. electrode diameter selector
- e. VRD function indicator
- f. Parameter adjustment knob
- g. MMA parameter selection
- h. Remote control enable (optional) (The standard version does not have the key and the indicator will not be on during working)

6.2. Display of parameters and error codes





- 1) When not welding, the current parameter setting value will be automatically displayed.
- 2) When welding, the actual output current value is displayed.
- 3) When the factory settings are restored the countdown is displayed.
- 4) When the barcode queried the machine barcode is displayed.
- 5) When the product is not working correctly an error code is displayed.

6.3. Parameter adjustment knob

- 1) Rotate the adjusting knob to adjust the parameters.
- 2) Rotating the adjusting knob clockwise increases the parameter value, and rotating the adjusting knob counterclockwise decreases the parameter value.
- 3) When the adjusting knob is rotated the adjusted parameters are displayed in the parameter display area.

6.4. Selection of working mode



- 1) Before welding, press the welding mode key  to switch between MMA and TIG welding, and select the corresponding mode based on the welding process requirement.
- 2)  If the indicator is on, this indicates the MMA mode is selected.
- 3)  If the indicator light is on, this indicates the TIG mode is selected .

6.5. Selection of welding electrode diameter for MMA

φ ●●●

φ 2.5

φ 3.2

φ 4.0







- 1) In MMA mode, press the electrode diameter selection key  to select the welding electrode diameter in Manual mode and Synergic mode.
- 2) φ ●●● The indicator is on, indicating that the Manual mode is selected and current is adjusted manually.
- 3) If φ2.5 mm\ φ3.2 mm\ φ4.0 mm indicator is on, this indicates the electrode diameter Synergic mode is selected.

NOTE! In the Synergic mode, the optimal welding parameters are automatically selected based on the electrode diameter, and the welding current is fine-tuned by adjusting the knob. Other parameters are not adjustable.

6.6. Selection of MMA parameters



- 1) In MMA mode and Manual mode, the parameters of welding current, Hot start current and Arc force can be selected by pressing the button  of MMA parameter selection.
- 2)  If the indicator light is on, this indicates the current parameter welding current. The welding current can be set by rotating the adjusting knob.
- 3)  If the indicator light is on, this indicates the Hot start current parameter is selected. The Hot start current can be set by rotating the adjusting knob.
- 4)  If the indicator light is on, this indicates the Arc force current parameter is selected. The Arc force can be set by rotating the adjusting knob.

NOTE! When the machine panel is untouched for a period, it will automatically return to the welding current parameter setting.

6.7. LIFT TIG mode parameter setting

In the LIFT TIG welding mode, rotate the adjusting knob to set the current parameter.

6.8. Protection indicators





When the overheat indicator is on, this indicates that the welder has overheated and current ceases. When the welder cools, the indicator will go out.



When the overcurrent indicator is on, this indicates that the welder has entered the overcurrent protection mode and the welder stops producing current

6.9. VRD (Voltage reduction device) function indications

- 1) When the VRD function is not enabled, the VRD indicator light is off.
- 2) When the VRD function is enabled, the VRD indicator displays green  and no welding is performed, indicating that the VRD function is normal.
- 3) When the VRD function is enabled and no welding is performed the VRD indicator light displays red , indicating that the VRD function is abnormal.
- 4) When the VRD function is enabled the VRD indicator is not on during welding.

6.10. Barcode display

Before welding, press the welding mode key  and parameter adjustment knob for 3S at the same time the meter displays the machine barcode. Pressing any key or rotating the encoder you will find that the machine will immediately exit the barcode display. If you do not perform any operation on the panel, the barcode display automatically stops after 20s.



6.11. Restore factory settings

- 1) Before welding, press the welding mode key  for 5 seconds to return to factory defaults.
- 2) After pressing and holding for 1 second, the display window starts to count down from 3, when the countdown ends, and the factory settings are restored. If the button is released before the countdown ends the factory will not take place.
- 3) Factory defaults: MMA: Manual state, current: 80A; TIG current: 80A.

6.12. Wired hand-held remote control (optional)

(Not optional for standard version without remote control interface)







- 1) Before welding, press the remote-control function key  to enable the remote control function.
- 2)  The indicator will be lit indicating that the remote-control function is enabled. If the remote controller is connected, the remote controller controls the welding current. If no remote controller is connected the welding current is controlled by the panel adjuster.
- 3)  The indicator is not on, indicating that the remote-control function is prohibited; welding current is controlled by the panel adjuster.

6.13. Wireless remote control (optional)



(Not optional for standard version without remote control interface)



1) Wireless pairing connection

Before welding, press and hold the panel remote control function button  and the pairing button of the wireless remote controller  at the same time, hold for 2 seconds to perform wireless remote control pairing. During pairing, the blue indicator of wireless receiver module  flashes, after successful pairing, the indicator of remote control mode is on . At the same time the blue indicator of wireless receiver module  will be constant on and the welder display window displays "OK". After successful pairing, the welding current can be adjusted by "+" or "-" buttons on the wireless remote controller. The range of current is the current the minimum to maximum current value preset on the panel.

2) Disconnecting the wireless connection:

After the remote controller is successfully paired, press the remote control function button  on the panel or the pairing button  of the wireless remote controller for 2 seconds, and the wireless connection of the remote controller will be disconnected. After disconnecting the display window of the welder displays the character "FAL", and the green indicator of the wireless receiver module  will be constantly on.

7. Welding function operation



Warning! Before turning on the power supply make sure that the equipment is disconnected to the output. Otherwise, an unexpected arc may be started when the power is turned on. This can cause damage to the work piece and to personnel.



Warning! Be sure to wear appropriate protective equipment during welding or cutting operation. Arcs, spatter, smoke, and high temperatures produced in the process may cause injury to personnel.



Warning! After the power supply is turned off, the output voltage of the machine may continue for a period and then drop slowly. Please do not touch the conductive part of the output before the panel is extinguished.

7.1. MMA operation

7.1.1 Turn on the power switch.

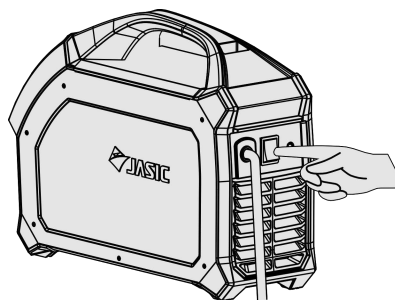

The power switch is located at the rear panel of the machine, set it in the "ON" position, then the panel indicator is on, the fan starts to rotate, and the welder starts to work normally.

NOTE! Some models are equipped with the smart fan function. When the power supply is turned on for a period before welding or cutting, the fan will automatically stop running. It will run automatically when welding or cutting begins.

7.1.2 Select MMA mode



7.1.3 Set the welding parameters when selecting the Manual mode.



The knob can adjust welding current, Hot start current and Arc force parameters respectively.

7.1.4 Select Synergic mode and set the welding parameters.



After selecting the electrode diameter the system will automatically select the welding current, Hot start current, and Arc force. Users can rotate the adjuster knob according to the welding requirements to fine-tune the welding current parameters.

The table below gives a guide to set up for various material thicknesses and welding electrode size. The operator can set their own parameters based on the type and diameter of welding electrode and their own process requirements.

	Workpiece thickness (mm)	Welding electrode diameter range (mm)	Welding electrode diameter (mm)	Welding current (A)
1	1~2	1.6	1.6	25~40
2	≤4	2.0~3.2	2.0	40~65
			2.5	50~80
			3.2	100~130
3	4~12	3.2~4.0	3.2	100~130
			4.0	160~210
3	≥4	≥4	5.0	200~270

			6.0	220~300
--	--	--	-----	---------

NOTE! The operator should set the functions that meet the welding requirements. If the selections are incorrect this may lead to problems such as an unstable arc, spatter, or sticking of the welding electrode to the work piece.

Arc force: Arc force prevents the electrode sticking when welding. Arc force provides a temporary increase in current when the arc is too short and helps maintain consistent excellent arc performance on a wide range of electrodes. The Arc force value should be determined according to welding electrode diameter, current setting, and process requirements. High arc force settings lead to a crisper, higher penetration arc but with some spatter. Lower arc force settings provide a smooth arc with lower spatter and a good weld seam formation, but sometimes the arc is soft or the welding electrode can stick.

Hot start current: The hot start current is an increase in welding current at the start of the weld to give excellent arc ignition and to avoid the electrode sticking. It also can reduce weld defects at the start of the weld. The magnitude of hot start current is generally determined based on the type, specification, and welding current of welding electrode.

During DC welding the heat on the positive and negative electrodes of the welding arc is different. When welding using DC power supply, there are DCEN (DC electrode negative) and DCEP (DC electrode positive) connections. The DCEN connection refers to the welding electrode connected to the negative electrode of the power supply and the work piece connected to the positive electrode of the power supply. In this mode the work piece receives more heat, resulting in high temperature, deep molten pool, easy to weld through, suitable for welding thick parts. The DCEP connection refers to the welding electrode connected to the positive power supply with the work piece connected to the negative power supply. In this mode the work piece receives less heat, resulting in low temperature, shallow pool, and difficulty in welding through. This is suitable for welding thin parts.

7.1.5 During welding

NOTE! This unit has anti-stick function by default. In the welding process, if short circuit occurs for 2 seconds, it will automatically enter anti-stick function. This means the welding current will automatically drop to 20A to allow the short circuit to be cleared. When the short circuit is cleared the welding current will automatically return to the set current.

7.1.6 Turn off the power supply after welding

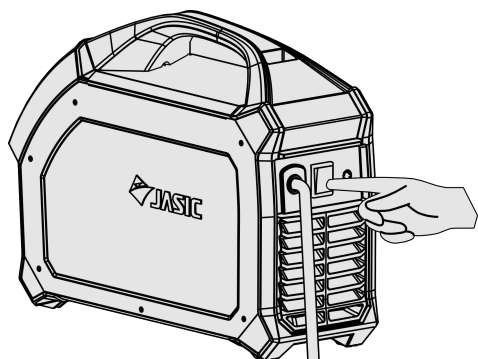

The power switch is located on the rear panel of the machine and set it to the "off" position. After a time delay, the panel indicator is off and the welder stops working.

7.2. LIFT TIG operation

7.2.1 Turn on the power switch.
(Same as 7.1.1)

7.2.2 Select TIG welding mode.



(LIFT TIG mode)

7.2.3 Set the welding parameters

In the LIFT TIG mode, set the welding current parameters using the knob.

Choose the appropriate welding current, tungsten electrode, and shielding gas flow based on the welding requirements. As a guide please refer to the following data.

Stainless steel plate-selection of parameters for manual TIG arc welding

Tungsten electrode diameter (mm)	Thickness of stainless steel plate (mm)	Maximum current (A)	Maximum argon flow rate (l/min)
1~2	1~3	50	5
		50~80	6
2~4	3~6	80~120	7
		121~160	8
		161~200	9
		201~300	10

7.2.3 LIFT TIG

Open the gas valve on the TIG welding torch. Touch the tungsten electrode to the work piece for less than 2 seconds and pull away approximately 2mm to start the arc. Alternatively, the arc can be started by scratching the tungsten electrode on the work piece and moving it away to around 2mm.

After welding, pull off the arc by raising the welding torch.

Close the gas valve on the TIG welding torch.

LIFT TIG mode has no torch switch operation mode.

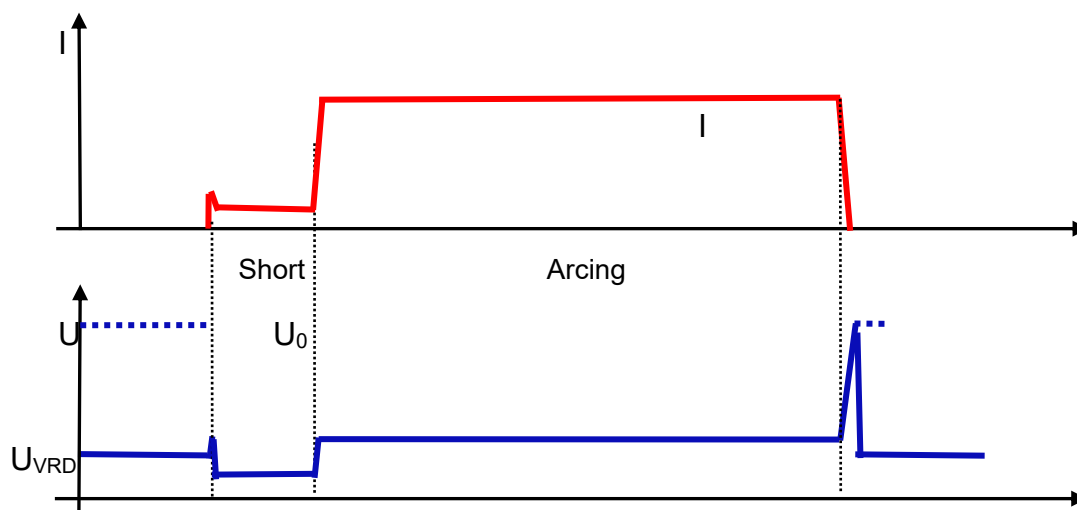

LIFT TIG process

NOTE! When starting the arc if the short-circuit time exceeds 2 seconds the welder turns off the output current. Lift the welding torch. Restart the process as above (7.3.2) to start the arc again.

NOTE! During welding, if there is short circuit between tungsten electrode and the work piece, the welder will immediately reduce the output current; if the short circuit exceeds 1 second, the welder will turn off the output current. If this happens, the arc will need to be restarted as above (7.3.2). and the welding torch needs to be lifted to start the arc again.

7.2.4 Turn off the power supply after welding (As above 7.1.6)

8. Maintenance



Warning!

The following operation requires sufficient professional knowledge on electric aspects and comprehensive safety knowledge. Make sure the input cable of the machine is disconnected from the electricity supply and wait for 5 minutes before removing the machine covers.

Please note: The following should only be carried out by an authorised electrical technician.

8.1 Power supply maintenance

In order to guarantee that the machine works efficiently and in safety, it must be maintained regularly. Operators should understand the maintenance methods and means of the machine operation. This guide should enable customers to carry out simple examination and safeguarding by oneself, try to reduce the fault rate and repair times of the machine, so as to lengthen service life of the machines.

<u>Period</u>	<u>Maintenance item</u>
Daily examination	Check the condition of the machine, mains cables, welding or cutting cables and connections. Check for any warnings LEDs and machine operation.
Monthly examination	Disconnect from the mains supply and wait for at least 5 minutes before removing the cover. Check internal connections and tighten if required. Clean the inside of the machine with a soft brush and vacuum cleaner. Take care not to remove any cables or cause damage to components. Ensure that ventilation grills are clear. Carefully replace the covers and test the unit. This work should be carried out by a suitably qualified competent person.
Yearly examination	Carry out an annual service to include a safety check in accordance with the manufacturers standard (EN 60974-1). This work should be carried out by a suitably qualified competent person.

8.2 Welding torch maintenance

The TIG torch used for lift TIG welding comprises of several items which ensure current flow and arc shielding from the atmosphere.

Regular maintenance of the welding torch is one of the most important measures to ensure its normal operation and extend lifespan. In order to ensure normal maintenance, the wearing parts of the torch should have spares, including the electrode holder, nozzle, sealing ring, insulating washer, etc. Common faults of the welding torch include overheating, gas leakage, water leakage, poor gas protection, electric leakage, nozzle burn out, and cracking. The causes of these faults and troubleshooting methods are as shown in the following table:

Symptom	Reasons	Troubleshooting
The welding torch is overheated	The welding torch capacity is too small	Replace with a welding torch with large capacity
	The cooling water pipe is blocked, resulting in blockage or low cooling water flow	Blow the cooling pipe with compressed air to clear the blockage
	The collet fails to clamp the tungsten electrode	Replace the collet or back cap
Water leakage	The sealing ring is aged	Replace the sealing ring
	The water pipe joint is damaged or not fastened	Reconnect the water pipe and tighten it
	The welding bead between the welding torch and the water inlet pipe is leaking	Open up to repair the welding
Air leakage	The sealing ring is aged	Replace the sealing ring
	The connecting thread is loose	Tighten it
	The gas inlet pipe joint is damaged or not fastened	Cut off the damaged joint, reconnect and tighten the replaced gas inlet pipe or wrap up the damaged area
	The gas inlet pipe has been damaged by heat or aging	Replace the gas inlet pipe
Electric leakage	The torch head is wet due to leakage or other reasons	Find the cause of water leakage, and fully dry the torch head
	The torch head is damaged or the live metal part is exposed	Replace the torch head or wrap the exposed electrified metal part with adhesive tape
Poor gas protection	The welding torch is leaking	Locate the leakage
	The nozzle diameter is too small	Replace with a nozzle of larger diameter

	The nozzle is damaged or cracked	Replace with a new nozzle
	The gas circuit in the welding torch is blocked	Blow the circuit with compressed air to clear the blockage
	The gas screen has been damaged or lost during disassembly and assembly	Replace with a new gas screen
	The argon gas is impure	Replace with standard argon gas
	The gas flow is too large or small	Adjust the gas flow properly
Arcing and burning of metal nozzle	The insulation gasket burns out and losses its insulation function	Replace the insulation gasket
	The insulation gasket is broken down by high frequency	Replace the insulation gasket
Arc started between the collet and tungsten electrode or welding torch	The collet and tungsten electrode have poor contact, or arc is started when the tungsten electrode contacts the base metal	Replace the collet or repair
	The collet and welding torch have poor contact	Connect the collet and welding torch properly

9. Troubleshooting



Warning! Before arc welding machines are dispatched from the factory, they have already been checked thoroughly. The machine should not be tampered with or altered. Maintenance must be carried out carefully. If any wire becomes loose or is misplaced, it maybe potentially dangerous to user! Only professional maintenance personnel should repair the machine!
Ensure the power is disconnected before working on the machine. Always wait 5 minutes after power switch off before removing the panels.

9.1. Common malfunction analysis and solution



The symptoms listed here may be related to the accessories, gas, environmental factors, and power supply you use. Please try to improve the environment and avoid such situations.

Elimination of general problems in MMA

Symptom		Reasons	Measures taken by users
After startup, the fan does not run, or the speed is abnormal		The air temperature is too low, or the fan is damaged	When the temperature is too low, you should leave the machine work for a while. Wait for the temperature in the machine to rise and fan to rotate normally. If it does not work, replace the fan.
MMA	Hard to start the arc	Hot start current is low Or the hot start time is short	Increase hot start current or hot start time
	Unstable arc, start or excessive molten pool during arc start	Hot start current is high Or the hot start time is long	Reduce hot start current or hot start time appropriately
	Cannot start normal arc	The power cord is not connected properly	Connect the power cord
	Welding slag difficult to remove	Low arc force current	Increase the arc force current
	Hot electrode holder	The rated current of electrode holder is too low	Change the electrode holder with a higher current one
	Arc is easily interrupted	Low mains voltage	Use after the mains power is normal

Other failures	Please contact the maintenance personnel of Shenzhen JASIC Technology CO., Ltd.
----------------	---

Elimination of general problems in LIFT TIG welding

Symptom		Reasons	Measures taken by users
After startup, the fan does not run, or the speed is abnormal		The air temperature is too low, or the fan is damaged	When the temperature is too low, leave the machine work for while, wait for the temperature in the machine to rise and fan to rotate normally. If it does not work, replace the fan.
LIFT TIG welding	No current output when the tungsten electrode is shorted with the workpiece	Welding circuit is blocked	Check the welding circuit and reconnect it
	Rapid tungsten electrode burnout	Welding torch and earth cable are connected to the wrong polarity	Switch two plug positions (torch to negative polarity)
	Blackening of weld joints	Welds are not effectively protected and oxidized	(1) Make sure that the valve of argon cylinder has been opened and there is enough pressure. Generally, if the pressure in the cylinder is lower than 0.5 MPa, it is necessary to refill the cylinder. (2) Check whether the argon flow rate is normal. You can choose different flow rates according to different welding current conditions, but too low a flow rate may lead to insufficient shielding gas to cover all weld joints. It is suggested that the argon flow rate should no less than 5L/min no matter how small the current is. (3) Check whether the gas passage is leaking, or whether the gas purity is too low. (4) Check whether there is strong ambient air flow in the environment.
	Hard to start arc Arc is easy to be interrupted	Poor quality of tungsten electrode or serious oxidation of the tungsten electrode	(1) Replace tungsten electrode with higher quality. (2) The tungsten is contaminated (3) Increase the post flow time to avoid tungsten oxidation.

	<p>Unstable current in welding process</p>	<p>The voltage of the power grid changes seriously or the joint contact with the power grid is poor. Serious interference from other electrical equipment.</p>	<p>(1) Check whether the power grid is normal and well connect the power connector. (2) Use different power cords to connect equipment that could seriously interfere with welder.</p>
<p>Other failures</p>			<p>Please contact the maintenance personnel of Shenzhen JASIC Technology CO., Ltd.</p>

9.2. Alarm and solutions

Error code	Category	Possible cause	Counter-measure
E10	Overcurrent protection	Continuously output the maximum capacity current of welder	Restart the welder. If overcurrent protection still activates, please contact the after-sales department of the company.
E31	Under voltage protection	Input network voltage is too low	Please turn it off and reboot. If this phenomenon persists and the grid voltage continues to be too low, please check the power grid voltage and wait for the grid to be normal before welding. If the grid voltage is normal and there is still under voltage alarm, please contact professional maintenance personnel. (The standard version does not have the function)
E32	Over voltage protection	Input network voltage is too high	Please turn it off and restart. If this phenomenon persists and the grid voltage continues to be too high, please check the power grid voltage and wait for the grid voltage to return to normal before welding. If the grid voltage is normal and there is still under voltage alarm, please contact professional maintenance personnel. .
E34	Under voltage protection	Driving under voltage	Please turn it off and restart it. If this phenomenon persists, please contact professional maintenance personnel.
E61	Overheat	Inverter IGBT temperature is too high	Do not turn off the machine. Wait for a while, and then continue welding after the overheat indicator turns off.
E62	Overheat	Output rectifier diode temperature is too high	Do not turn off the machine. Wait for a while, and then continue welding after the overheat indicator turns off.
	Abnormal VRD	No-load voltage is too high	Please turn it off and restart it. If this phenomenon persists, please contact professional maintenance personnel.

NOTE! After applying the above countermeasures, the alarm still persists or reappears after lifting. Please contact professional maintenance personnel.

10. Packaging, transportation, storage and waste disposal

10.1 Transportation requirements

In the process of handling the equipment, it should be handled with care, and should not be dropped or severely impacted. Avoid moisture and rain during transportation.

10.2 Storage conditions

Storage temperature: $-25\text{ }^{\circ}\text{C} \sim +50\text{ }^{\circ}\text{C}$

Storage humidity: relative humidity $\leq 90\%$

Storage period: 12 months

Storage site: indoors with no corrosive gas and air circulation

10.3 WEEE waste disposal

Disposal

The equipment is manufactured with materials, which do not contain any toxic or poisonous materials dangerous to the operator.

When the equipment is scrapped, it should be dismantled separating components according to the type of materials.

Do not dispose of the equipment with normal waste. The European Directive 2002/96/EC on Waste Electrical and Electronic Equipment states the electrical equipment that has reached its end of life must be collected separately and returned to an environmentally compatible recycling facility.

In order to comply with WEEE regulations in your country you should contact your supplier.

RoHS Compliance Declaration

We herewith confirm, that the above mentioned product does not contain any of the restricted substances as listed in EU Directive 2011/65/EC in concentrations above the limits as specified therein.

Disclaimer: Please note that this confirmation is given to the best of our present knowledge and belief. Nothing herein represents and/or may be interpreted as warranty within the meaning of the applicable warranty law.

Appendix 1: Wiring diagram

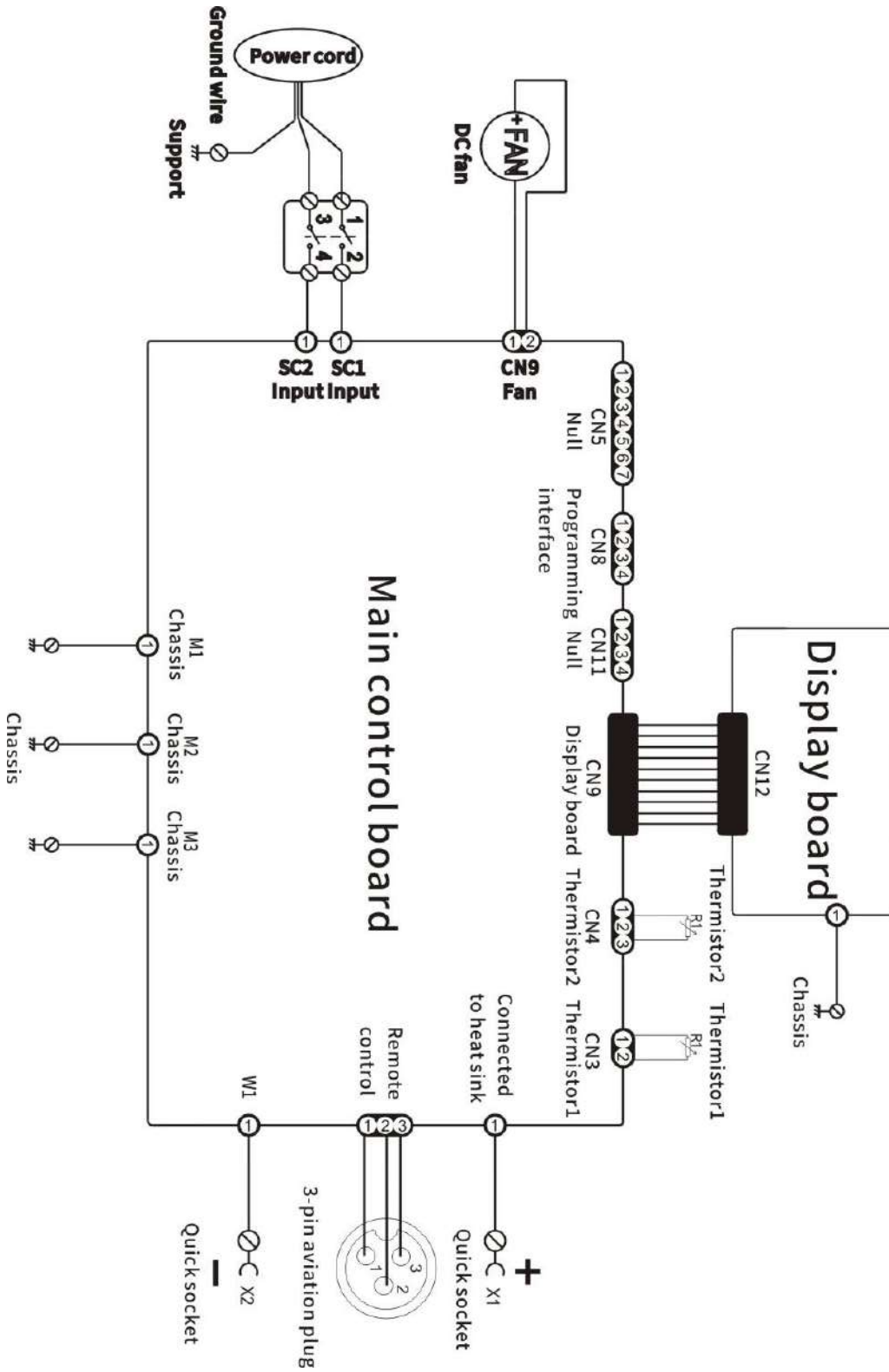

Appendix 2: Exploded view of ARC160 and ARC200

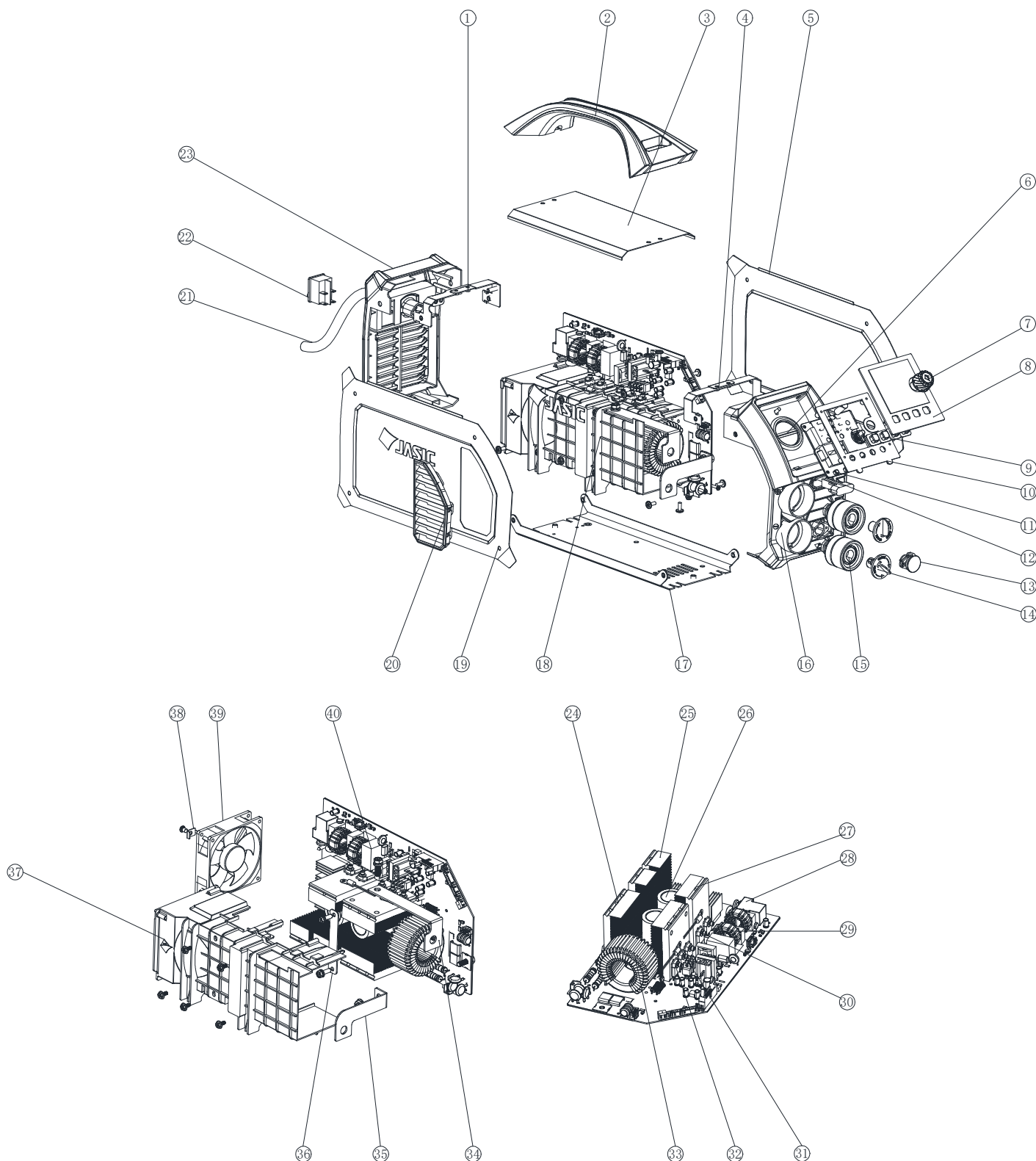

List of common spare parts for ARC160

SN	Material code	Name	Quantity	SN	Material code	Name	Quantity
1	10083448	Rear bracket	1	20	10083485	Side louver	1
2	10083468	Handle	1	21	51001928	Power cord	1
3	10083527	Top cover (plus)	1	22	51000471	Rocker switch	1
	51001979	Top cover (standard)	1	23	10083469	Rear panel	1
4	10083446	Front bracket	1	24	10083455	62mm heat sink	1
5	10083440	Right cover	1	25	10083459	35mm heat sink	2
6	10083208	Protective ring	1	26	51000901	Electrolytic capacitor	2
7	10083484	Knob	1	27	10083457	50mm heat sink	1
8	10083515	Display panel (plus)	1	28	51000643	Relay	1
	51002054	Display panel (standard)	1	29	51000700	EMC inductor	2
9	10083453	Silicone key	1	30	51000602	IGBT	4
10	10083474	Iron plate of display panel	1	31	51000703	Thermocouple	2
11	51000401	Display panel PCBA	1		51000702		
12	10083487	Plug	1	32	10064546	Rectifier tube	4
13	51000383	Aviation socket (plus)	1	33	10071746	Main transformer	1
14	10083486	Quick socket plug (standard)	2	34	10083444	Positive connector	1
15	10021855	Quick socket	2	35	10083436	Negative connector	1
16	10083470	Front panel (plus)	1	36	10083443	Heat sink connector	1
	10086152	Front panel (standard)	1	37	10083472	Wind shield	1
17	10083435	Chassis (plus)	1	38	10083447	Fan presser	2
	51001980	Chassis (standard)	1	39	10056858	Fan	1
18	51000466	Inverter	1	40	51000463	Main board (plus)	1
19	10083450	Left cover	1		51002086	Main board (standard)	1

List of common spare parts for ARC200

SN	Material code	Name	Quantity	SN	Material code	Name	Quantity
1	10083448	Rear bracket	1	20	10083485	Side louver	1
2	10083468	Handle	1	21	51001928	Power cord	1
3	10083527	Top cover (plus)	1	22	10083524	Rocker switch	1
	51001979	Top cover (standard)	1	23	10083469	Rear panel	1
4	10083446	Front bracket	1	24	10083455	62mm heat sink	1
5	10083440	Right cover	1	25	10083459	35mm heat sink	2
6	10083208	Protective ring	1	26	51000899	Electrolytic capacitor	2
7	10083484	Knob	1	27	10083457	50mm heat sink	1
8	10083458	Display panel	1	28	10066349	Relay	1
	51002053	Display panel (standard)	1	29	51000700	EMC inductor	2
9	10083453	Silicone key	1	30	51000601	IGBT	4
10	10083474	Iron plate of display panel	1	31	51000703	Thermistor	2
11	51000401	Display panel PCBA	1		51000702		
12	10083487	Plug	1	32	10064546	Rectifier tube	6
13	51000383	Aviation socket (plus)	1	33	10083488	Main transformer	1
14	10083486	Quick socket plug (standard)	2	34	10083444	Positive connector	1
15	10021855	Quick socket	2	35	10083436	Negative connector	1
16	10083470	Front panel (plus)	1	36	10083443	Heat sink connector	1
	10086152	Front panel (standard)	1	37	10083472	Wind shield	1
17	10083435	Chassis (plus)	1	38	10083447	Fan presser	2
	51001978	Chassis (standard)	1	39	10056858	Fan	1
18	51000442	Inverter	1	40	51000449	Main board (plus)	1
19	10083450	Left cover	1		51000450	Main board (standard)	1

Appendix 3: Exploded view of ARC160PFC and ARC200PFC

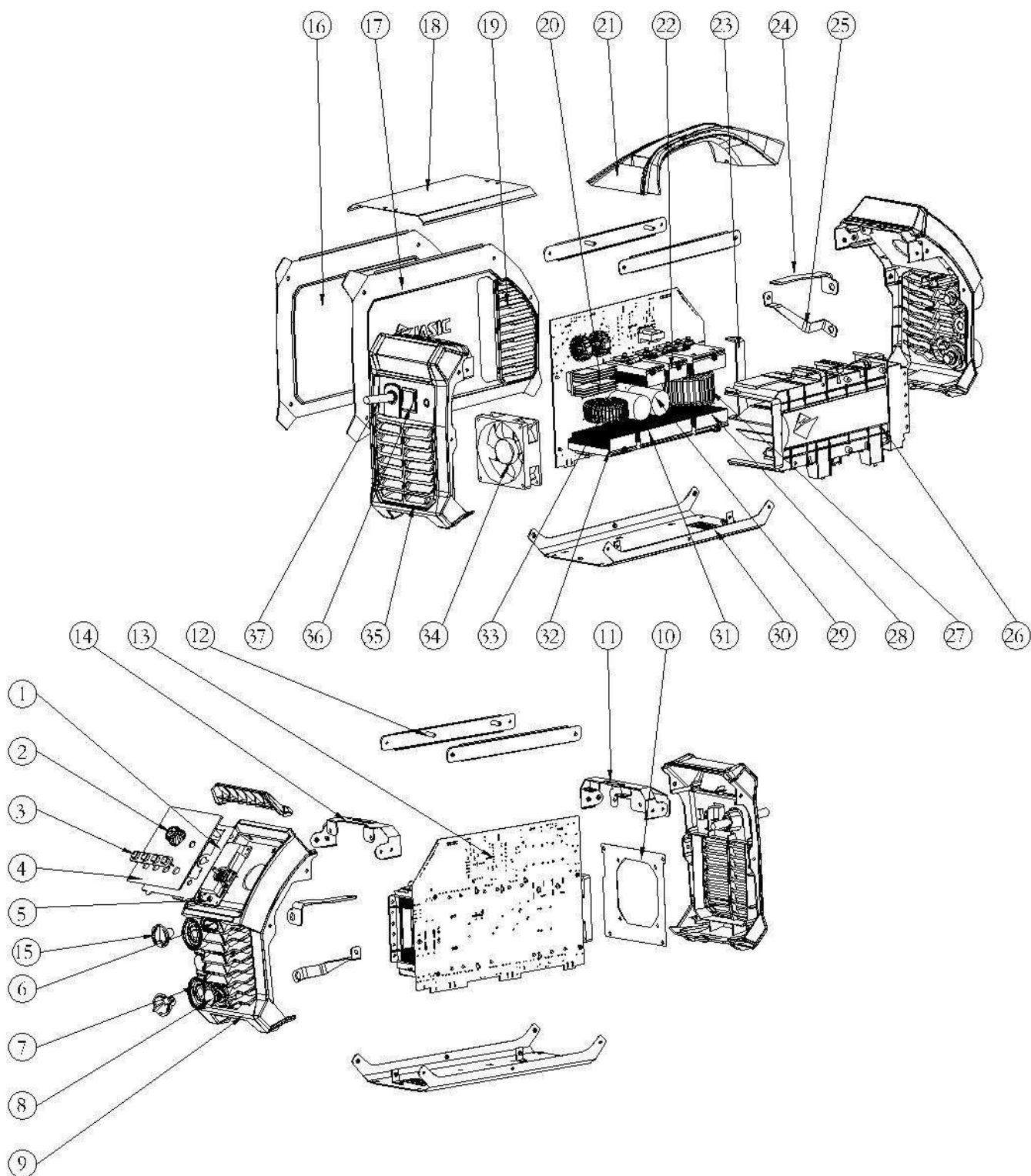

List of common spare parts for ARC160PFC

SN	Material code	Name	Quantity	SN	Material code	Name	Quantity
1	10083652	Iron plate of	1	19	10083671	Louver	1

		display panel					
2	10083484	Knob	1	20	10050418	Rectifier bridge radiator	2
3	51000374	Silicone key	1	21	10083690	Handle	1
4	10083612	Front panel sticker (plus)	1	22	10083625	Heat sink	2
	51001885	Front panel sticker (standard)	1	23	10083638	Aluminum connector	1
5	51000464	Display panel PCB board	1	24	10083640	Output aluminum connector	1
6	10083487	Plug	1	25	10083642	Output copper connector	1
7	10021855	Quick socket	2	26	10083689	Wind shield	1
8	51000384	Aviation socket (plus)	1	27	10083490	Main transformer	1
9	10083669	Rear panel	1	28	10083628	Diode heat sink	2
	10083670	Front panel	1	29	51000937	Electrolytic capacitor	2
10	10083646	Fan mounting plate	1	30	10083647	Chassis (plus)	1
11	10083654	Rear panel bracket	1		51002018	Chassis (standard)	1
12	10083655	Beam	1	31	10083629	IGBT heat sink	1
13	51000460	Main board PCB (plus)	1	32	10083626	PFC IGBT heat sink	1
	51002115	Main board PCB (standard)	1	33	51000456	PFC inductor	1
14	10083653	Front panel bracket	1	34	10064197	Fan	1
15	10083486	Quick socket plug (standard)	2	35	10083670	Rear panel	1
16	10083650	Left cover	1	36	51000471	Switch	1
17	10083651	Right cover	1	37	51001928	Power cord	1
18	10083649	Top cover (plus)	1				
	51002017	Top cover (standard)	1				

List of common spare parts for ARC200PFC

SN	Material	Name	Quantity	SN	Material	Name	Quantity
----	----------	------	----------	----	----------	------	----------

	code				code		
1	10083652	Iron plate of display panel	1	19	10083671	Louver	1
2	10083484	Knob	1	20	10050418	Rectifier bridge radiator	2
3	51000374	Silicone key	1	21	10083690	Handle	1
4	10083612	Front panel sticker (plus)	1	22	10083625	Heat sink	2
	51001885	Front panel sticker (standard)	1	23	10083638	Aluminum connector	1
5	51000464	Display panel PCB board	1	24	10083640	Output aluminum connector	1
6	10083487	Plug	1	25	10083642	Output copper connector	1
7	10021855	Quick socket	2	26	10083689	Wind shield	1
8	51000384	Aviation socket (plus)	1	27	10083490	Main transformer	1
9	10083669	Rear panel	4	28	10083628	Diode heat sink	2
	10083670	Front panel	4	29	51000937	Electrolytic capacitor	2
10	10083646	Fan mounting plate	1	30	10083647	Chassis (plus)	1
11	10083654	Rear panel bracket	1		51002018	Chassis (standard)	1
12	10083655	Beam	1	31	10083629	IGBT heat sink	1
13	51000460	Main board PCB (plus)	1	32	10083626	PFC IGBT heat sink	1
	51002115	Main board PCB (standard)	1	33	51000456	PFC inductor	1
14	10083653	Front panel bracket	1	34	10064197	Fan	1
15	10083486	Quick socket plug (standard)	2	35	10083670	Rear panel	1
16	10083650	Left cover	1	36	51000471	Switch	1
17	10083651	Right cover	1	37	51001928	Power cord	1
18	10083649	Top cover (plus)	1				
	51002017	Top cover (standard)	1				